



Pololu Micro Metal Gearmotors are available in a variety of different gear ratios, from 5:1 up to 1000:1, and with five different motor options:

- **LP 6V:** Low-power 6 V with precious metal brushes
- **MP 6V:** Medium-power 6 V with precious metal brushes
- **HP 6V:** High-power 6 V with precious metal brushes
- **HPCB 6V:** High-power 6 V with long-life carbon brushes
- **HPCB 12V:** High-power 12 V with long-life carbon brushes



Each motor is available with an optional extended rear motor shaft to allow for the addition of an encoder such as Pololu items **#4760** (<https://www.pololu.com/product/4760>) and **#4761** (<https://www.pololu.com/product/4761>) Magnetic Encoder Pair Kits.

Dimensions of versions with carbon brushes (HPCB)

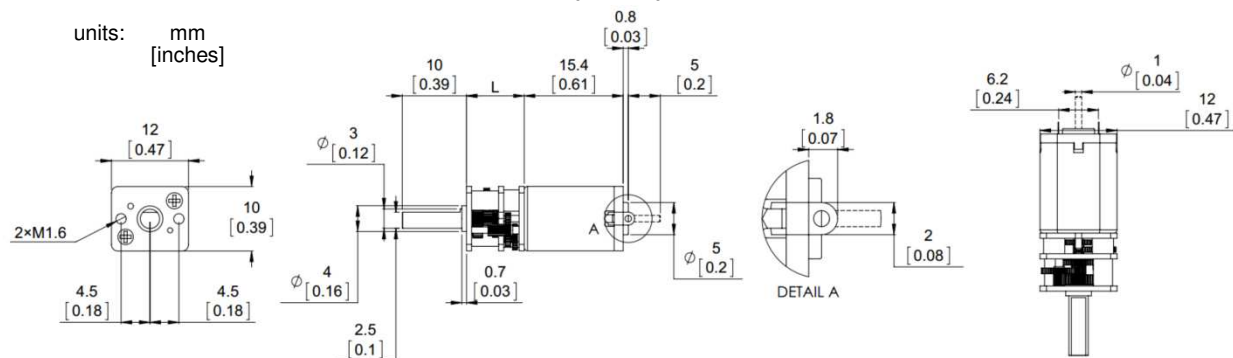

Dimensions of versions with precious metal brushes (HP, MP, LP)

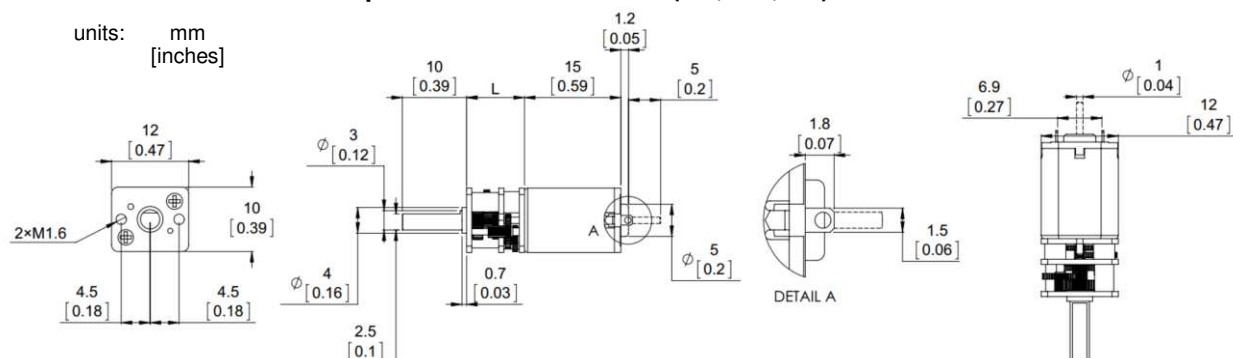

L = 9 mm [0.35 in] for all gear ratios except 1000:1. **L = 12.5 mm [0.49 in]** for the 1000:1 gear ratio. Max length for M1.6 mounting screws is 1.3 mm (from gearbox mounting surface). Approximate weight is 10 g.

Performance summary and table of contents

Motor Type	Rated Voltage	Pololu Item #	Gear Ratio	No Load		At Maximum Efficiency					Max Power W	Stall Extrapolation ⁽²⁾		Graph Page
				Speed	Current	Speed	Torque	Current	Output	Efficiency		Torque	Current	
				:1	RPM (±20%)	mA (±50%)	RPM	kg-mm	A	W		%	kg-mm	
Low-Power (LP 6V)	6 V	1100, 2200	4.995	2500	50	- ⁽¹⁾	- ⁽¹⁾	- ⁽¹⁾	- ⁽¹⁾	- ⁽¹⁾	0.37	0.5	0.36	
		1099, 2201	9.96	1300		- ⁽¹⁾	- ⁽¹⁾	- ⁽¹⁾	- ⁽¹⁾	- ⁽¹⁾	0.37	1.0		
		4780, 4781	15.25	860		640	0.40	0.11	0.27	40	0.37	1.7		4
		993, 2202	29.86	450		320	0.66	0.11	0.22	34	0.31	2.9		5
		1098, 2203	51.45	270		200	1.0	0.10	0.20	34	0.29	4.4		6
		2360, 2209	75.81	180		140	1.3	0.10	0.19	33	0.29	6.4		7
		992, 2204	100.37	130		100	1.7	0.10	0.17	28	0.25	7.4		8
		1097, 2205	150.58	90		67	2.6	0.11	0.18	28	0.25	11		9
		1096, 2206	210.59	65		46	4.1	0.12	0.19	27	0.25	16		10
		1095, 2207	248.98	54		39	4.2	0.11	0.17	26	0.23	17		11
		1094, 2208	297.92	45		34	4.4	0.09	0.15	27	0.22	20		12
		4790, 4791	379.17	36		29	5.4	0.08	0.16	34	0.27	29		13
		1596, 3058	986.41	13		10	12	0.09	0.12	24	- ⁽³⁾	55		14
		Medium-Power (MP 6V)	6 V	2362, 2376	4.995	4400	80	- ⁽¹⁾	- ⁽¹⁾	- ⁽¹⁾	- ⁽¹⁾	- ⁽¹⁾		0.70
2363, 2377	9.96			2200		- ⁽¹⁾	- ⁽¹⁾	- ⁽¹⁾	- ⁽¹⁾	- ⁽¹⁾	0.70	1.1		
4782, 4783	15.25			1400		1000	0.47	0.21	0.50	39	0.70	2.0	15	
2364, 2378	29.86			720		510	0.80	0.21	0.41	33	0.57	3.3	16	
2365, 2379	51.45			420		310	1.2	0.19	0.38	33	0.55	5.4	17	
2366, 2380	75.81			290		220	1.6	0.17	0.35	34	0.54	7.8	18	
2367, 2381	100.37			220		170	1.9	0.17	0.32	33	0.50	9.4	19	
2368, 2382	150.58			150		110	2.6	0.15	0.30	33	0.48	13	20	
2369, 2383	210.59			100		83	3.4	0.16	0.29	31	0.46	17	21	
2370, 2384	248.98			88		69	4.5	0.17	0.31	31	0.48	22	22	
2371, 2385	297.92			73		56	5.0	0.17	0.29	29	0.44	24	23	
4792, 4793	379.17			57		46	6.9	0.16	0.33	34	0.53	36	24	
2372, 3059	986.41			22		17	13	0.16	0.23	24	- ⁽³⁾	67	25	
High-Power (HP 6V)	6 V			1000, 2210	4.995	6100	120	- ⁽¹⁾	- ⁽¹⁾	- ⁽¹⁾	- ⁽¹⁾	- ⁽¹⁾	1.6	1.1
		999, 2211	9.96	3100		2300	0.46	0.42	1.1	43	1.6	2.2	26	
		4784, 4785	15.25	2000		1600	0.58	0.37	0.95	42	1.5	3.0	27	
		1093, 2212	29.86	1000		830	1.0	0.36	0.89	41	1.5	5.7	28	
		998, 2213	51.45	590		490	1.5	0.32	0.75	38	1.3	8.6	29	
		2361, 2215	75.81	410		340	2.3	0.34	0.80	40	1.4	13	30	
		1101, 2214	100.37	310		250	2.9	0.33	0.73	37	1.3	17	31	
		997, 2386	150.58	210		170	3.9	0.31	0.68	37	1.2	24	32	
		996, 2216	210.59	150		120	5.0	0.32	0.62	32	1.1	30	33	
		995, 2217	248.98	120		100	5.5	0.30	0.59	32	1.1	34	34	
		994, 2218	297.92	100		87	6.5	0.31	0.58	31	1.1	40	35	
		4794, 4795	379.17	84		70	8.4	0.28	0.61	36	- ⁽³⁾	55	36	
		1595, 2373	986.41	31		26	20	0.32	0.53	28	- ⁽³⁾	120	37	
		High-Power, Carbon Brushes (HPCB 6V)	6 V	3060, 3082	4.995	6500	170	- ⁽¹⁾	- ⁽¹⁾	- ⁽¹⁾	- ⁽¹⁾	- ⁽¹⁾	1.3	0.9
3061, 3071	9.96			3300		2300	0.42	0.51	1.0	33	1.3	1.7	38	
4786, 4787	15.25			2100		1500	0.60	0.49	0.94	32	1.3	2.5	39	
3062, 3072	29.86			1100		840	1.0	0.43	0.85	33	1.2	4.5	40	
3063, 3073	51.45			650		490	1.6	0.42	0.80	32	1.2	7.4	41	
3064, 3074	75.81			430		330	2.5	0.43	0.87	34	1.3	11	42	
3065, 3075	100.37			330		260	3.3	0.44	0.86	33	1.3	16	43	
3066, 3076	150.58			220		170	4.1	0.39	0.73	31	1.1	20	44	
3067, 3077	210.59			160		120	5.9	0.40	0.74	31	1.1	28	45	
3068, 3078	248.98			130		100	6.6	0.40	0.71	29	1.1	32	46	
3069, 3079	297.92			110		85	7.4	0.42	0.65	26	1.0	34	47	
4796, 4797	379.17			85		68	10	0.40	0.71	30	- ⁽³⁾	50	48	
3070, 3080	986.41			33		26	22	0.39	0.59	25	- ⁽³⁾	110	49	
High-Power, Carbon Brushes (HPCB 12V)	12 V			3036, 3047	4.995	6800	100	- ⁽¹⁾	- ⁽¹⁾	- ⁽¹⁾	- ⁽¹⁾	- ⁽¹⁾	1.5	0.9
		3037, 3048	9.96	3400		2500	0.43	0.25	1.1	37	1.5	1.7	50	
		4788, 4789	15.25	2200		1700	0.59	0.23	1.0	37	1.4	2.5	51	
		3038, 3049	29.86	1100		840	1.0	0.23	0.82	30	1.1	3.9	52	
		3039, 3050	51.45	650		500	1.5	0.22	0.79	31	1.1	6.7	53	
		3040, 3051	75.81	450		350	2.1	0.20	0.76	31	1.1	10	54	
		3041, 3052	100.37	330		260	2.9	0.21	0.78	31	1.1	13	55	
		3042, 3053	150.58	220		170	4.2	0.22	0.73	28	1.0	18	56	
		3043, 3054	210.59	160		120	5.6	0.21	0.71	28	1.0	25	57	
		3044, 3055	248.98	130		110	6.6	0.21	0.72	29	1.1	30	58	
		3045, 3056	297.92	110		87	7.3	0.21	0.65	26	1.0	33	59	
		4798, 4799	379.17	85		67	11	0.20	0.75	31	- ⁽³⁾	50	60	
		3046, 3057	986.41	35		27	21	0.19	0.59	25	- ⁽³⁾	100	61	

Notes:

- (1) Max efficiency data and performance graphs currently unavailable for all 5:1 gear ratios and LP and MP 10:1 gear ratios.
- (2) Listed stall torques and currents are theoretical extrapolations; units will typically stall well before these points as the motors heat up. Stalling or overloading gearmotors can greatly decrease their lifetimes and even result in immediate damage. The recommended upper limit for instantaneous torque is 25 kg-mm for the 380:1 and 1000:1 gearboxes, and 20 kg-mm for all other gear ratios; **we strongly advise keeping applied loads well under these limits**. Stalls can also result in rapid (potentially on the order of seconds) thermal damage to the motor windings and brushes, especially for the versions that use high-power (HP and HPCB) motors; a general recommendation for brushed DC motor operation is 25% or less of the stall current.
- (3) Operating these versions at maximum power is likely to damage the gearboxes.

Exact gear ratios

Nominal	Exact	Nominal	Exact
5 : 1	$\frac{27 \times 37}{20 \times 10} = 4.995 : 1$	150 : 1	$\frac{25 \times 32 \times 34 \times 35 \times 38}{12 \times 11 \times 14 \times 13 \times 10} \approx 150.5828 : 1$
10 : 1	$\frac{35 \times 37}{13 \times 10} \approx 9.9615 : 1$	210 : 1	$\frac{25 \times 34 \times 34 \times 35 \times 38}{12 \times 9 \times 13 \times 13 \times 10} \approx 210.5906 : 1$
15 : 1	$\frac{25 \times 34 \times 31}{12 \times 9 \times 16} \approx 15.2488 : 1$	250 : 1	$\frac{25 \times 34 \times 37 \times 35 \times 38}{12 \times 10 \times 10 \times 14 \times 10} \approx 248.9792 : 1$
30 : 1	$\frac{31 \times 33 \times 35 \times 34}{16 \times 14 \times 13 \times 14} \approx 29.8609 : 1$	298 : 1	$\frac{25 \times 34 \times 37 \times 35 \times 38}{12 \times 9 \times 10 \times 13 \times 10} \approx 297.9238 : 1$
50 : 1	$\frac{32 \times 33 \times 35 \times 38}{15 \times 14 \times 13 \times 10} \approx 51.4462 : 1$	380 : 1	$\frac{25 \times 35 \times 39 \times 36 \times 39}{12 \times 9 \times 9 \times 13 \times 10} = 379.1\bar{6} : 1$
75 : 1	$\frac{34 \times 34 \times 35 \times 38}{13 \times 12 \times 13 \times 10} \approx 75.8126 : 1$	1000 : 1	$\frac{25 \times 34 \times 35 \times 34 \times 34 \times 34 \times 27}{12 \times 9 \times 12 \times 14 \times 14 \times 14 \times 9} \approx 986.4064 : 1$
100 : 1	$\frac{35 \times 37 \times 35 \times 38}{12 \times 11 \times 13 \times 10} \approx 100.3700 : 1$		

Pololu Items #4780, #4781 (15:1 Micro Metal Gearmotor LP 6V) Performance at 6 V

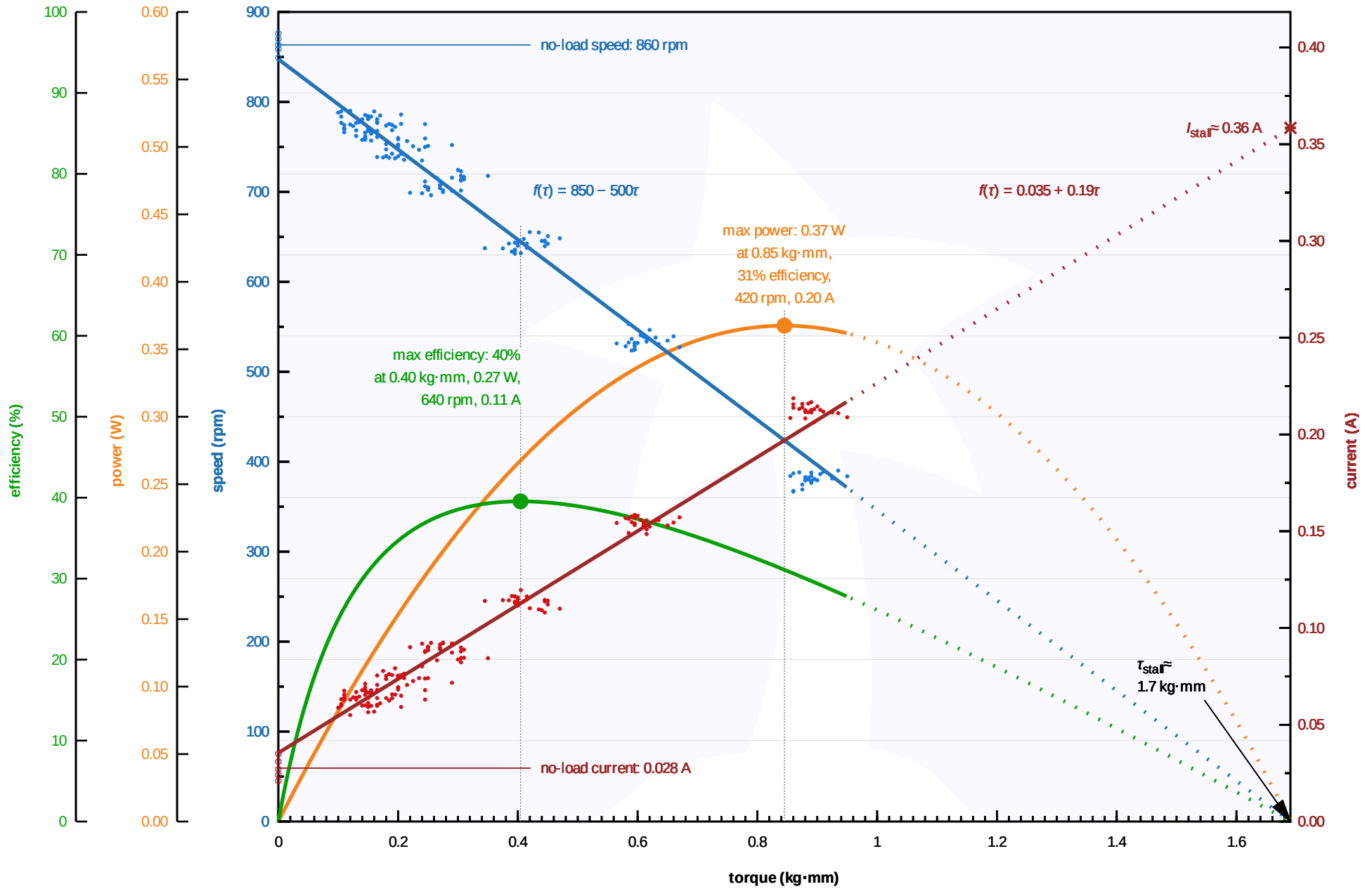

Pololu Items #993, #2202 (30:1 Micro Metal Gearmotor LP 6V) Performance at 6 V

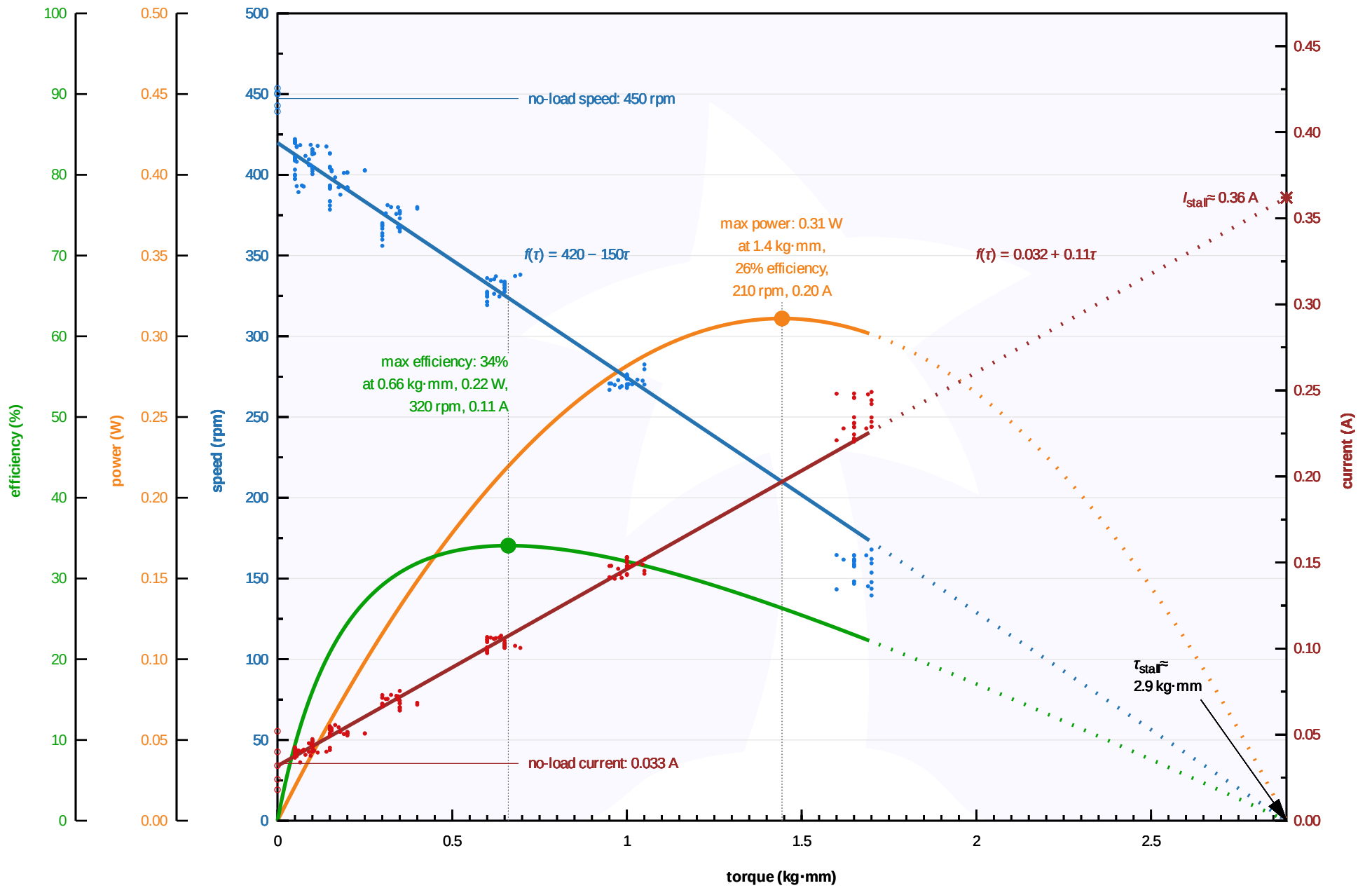

Pololu Items #1098, #2203 (50:1 Micro Metal Gearmotor LP 6V) Performance at 6 V

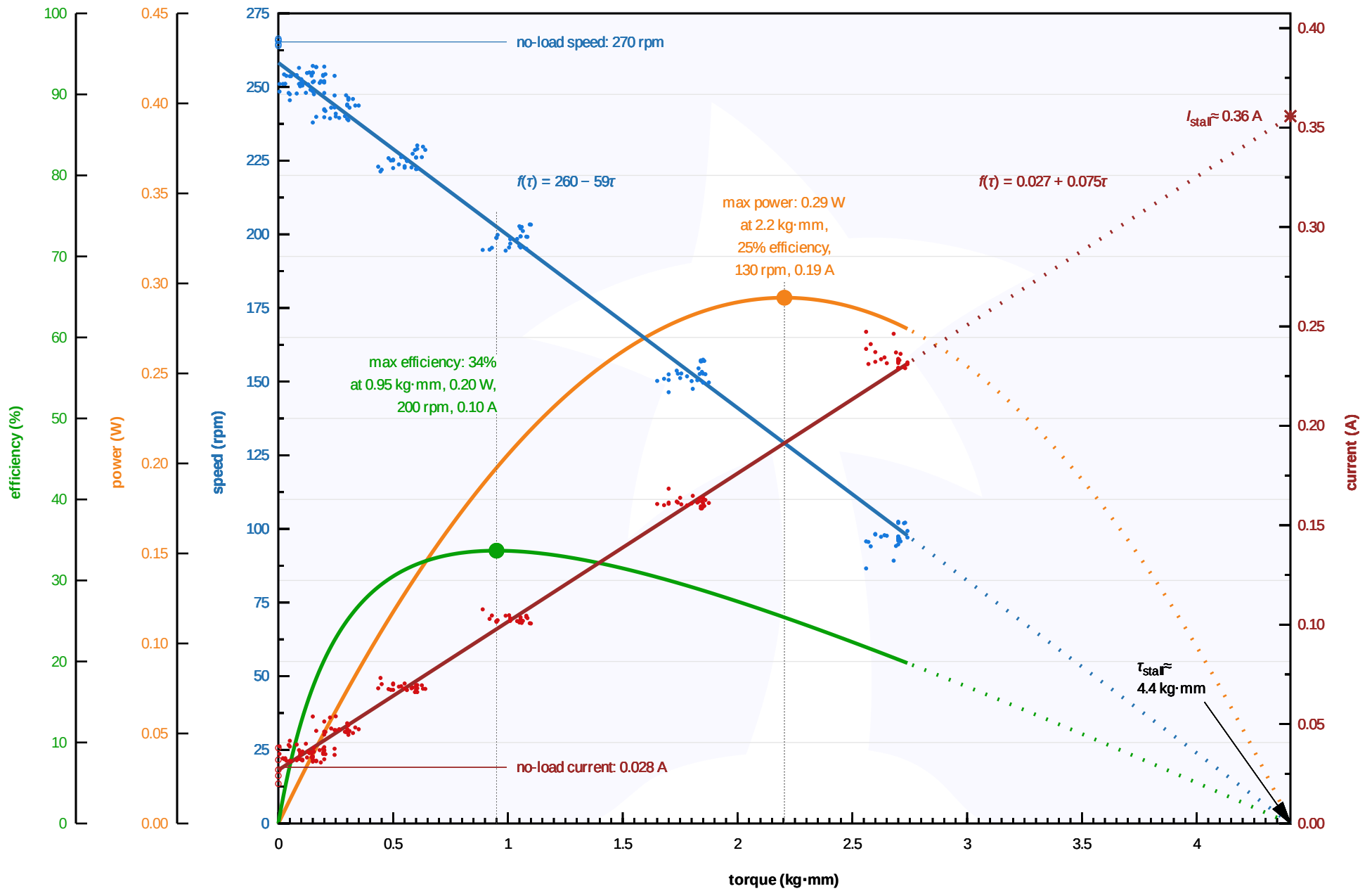

Pololu Items #2360, #2209 (75:1 Micro Metal Gearmotor LP 6V) Performance at 6 V

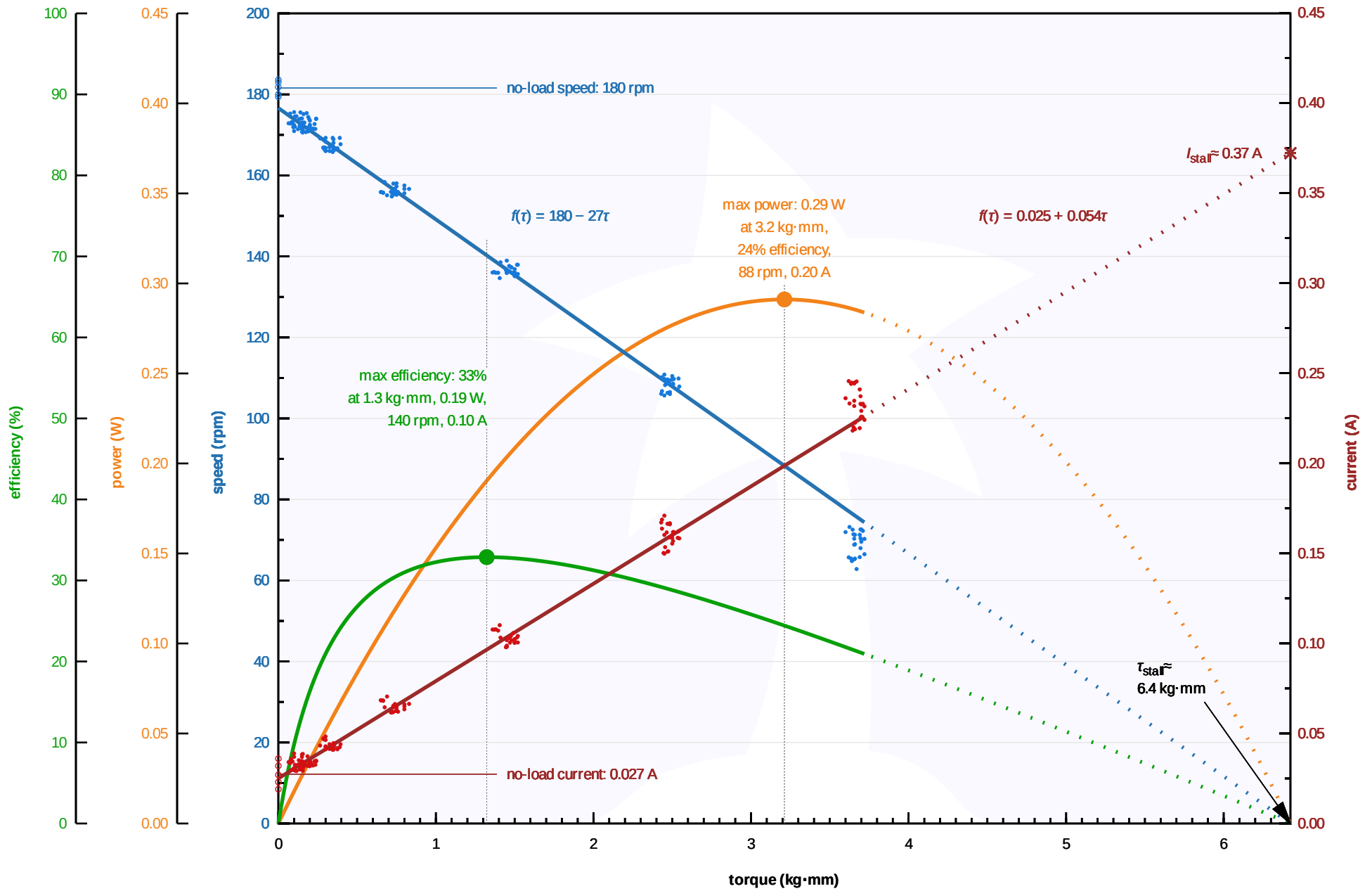

Pololu Items #992, #2204 (100:1 Micro Metal Gearmotor LP 6V) Performance at 6 V

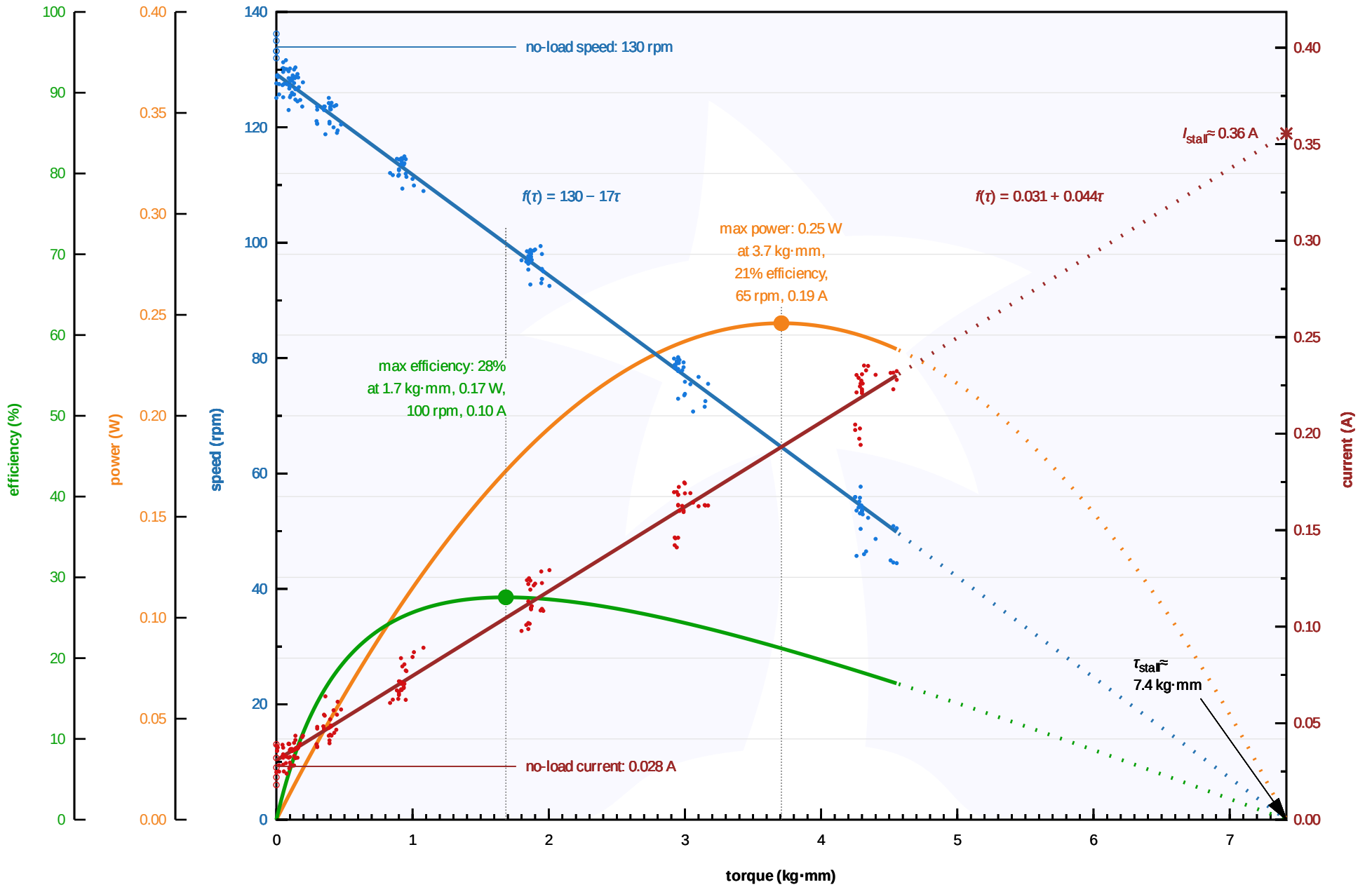

Pololu Items #1097, #2205 (150:1 Micro Metal Gearmotor LP 6V) Performance at 6 V

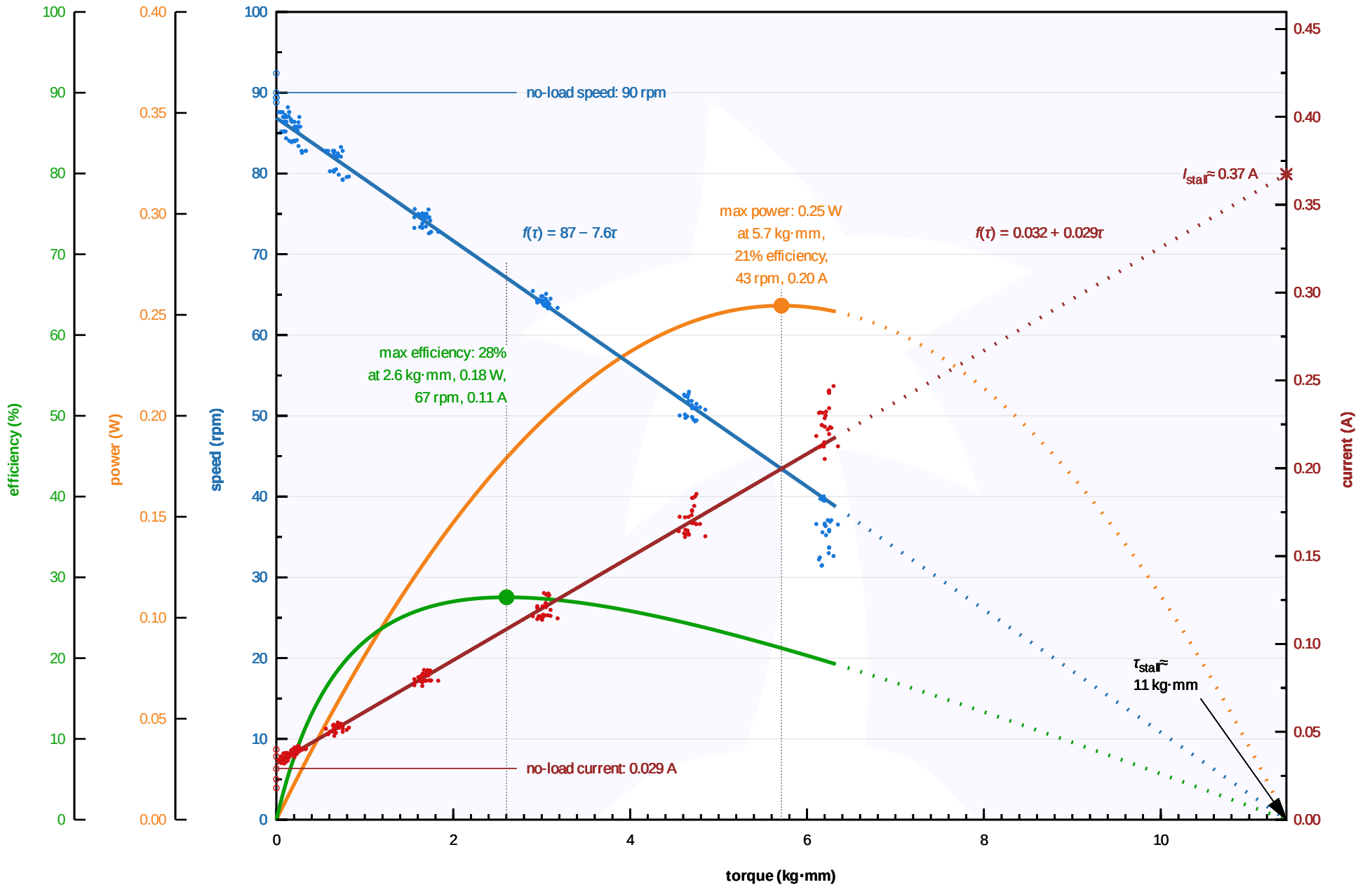

Pololu Items #1096, #2206 (210:1 Micro Metal Gearmotor LP 6V) Performance at 6 V

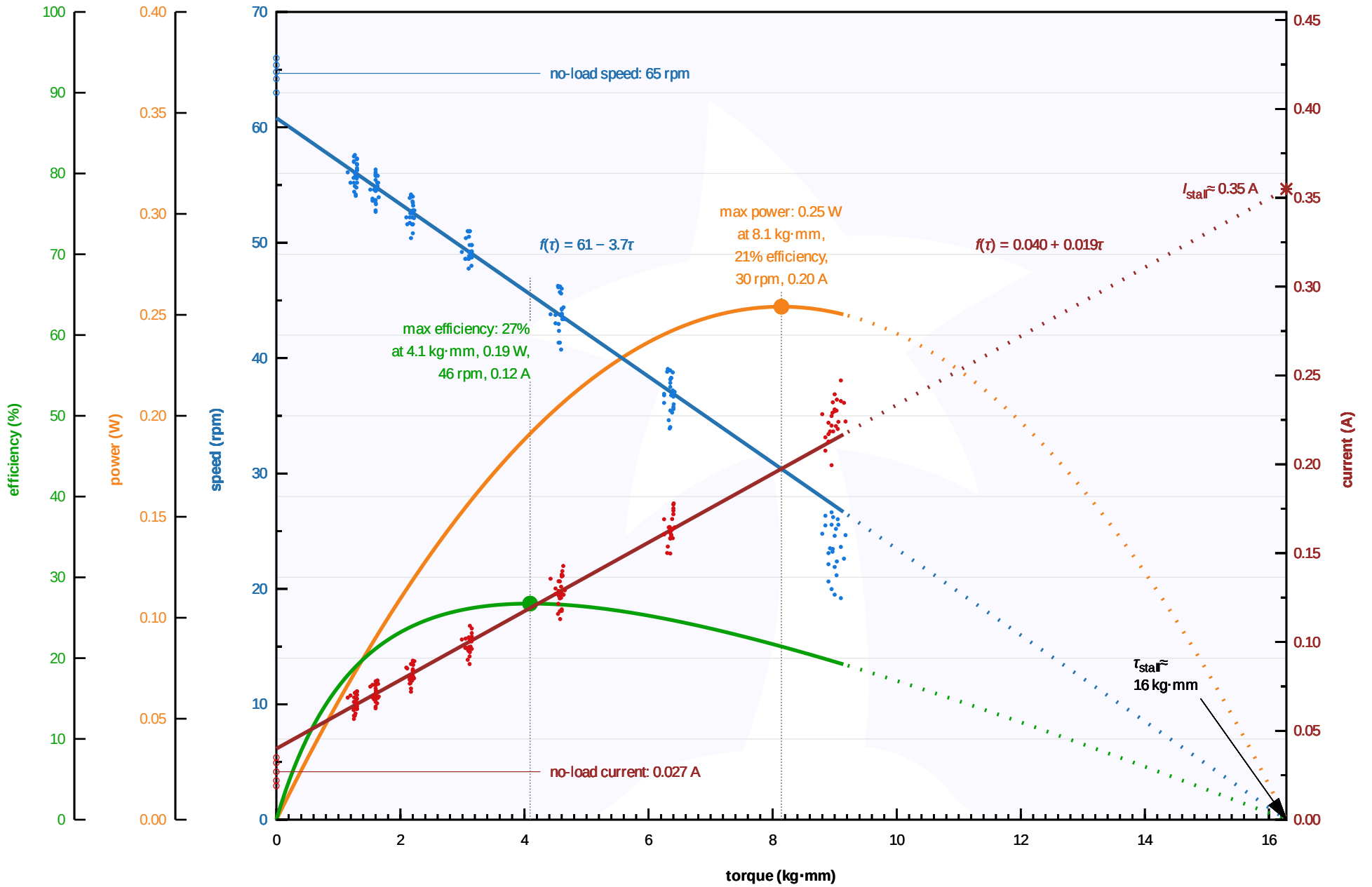

Pololu Items #1095, #2207 (250:1 Micro Metal Gearmotor LP 6V) Performance at 6 V

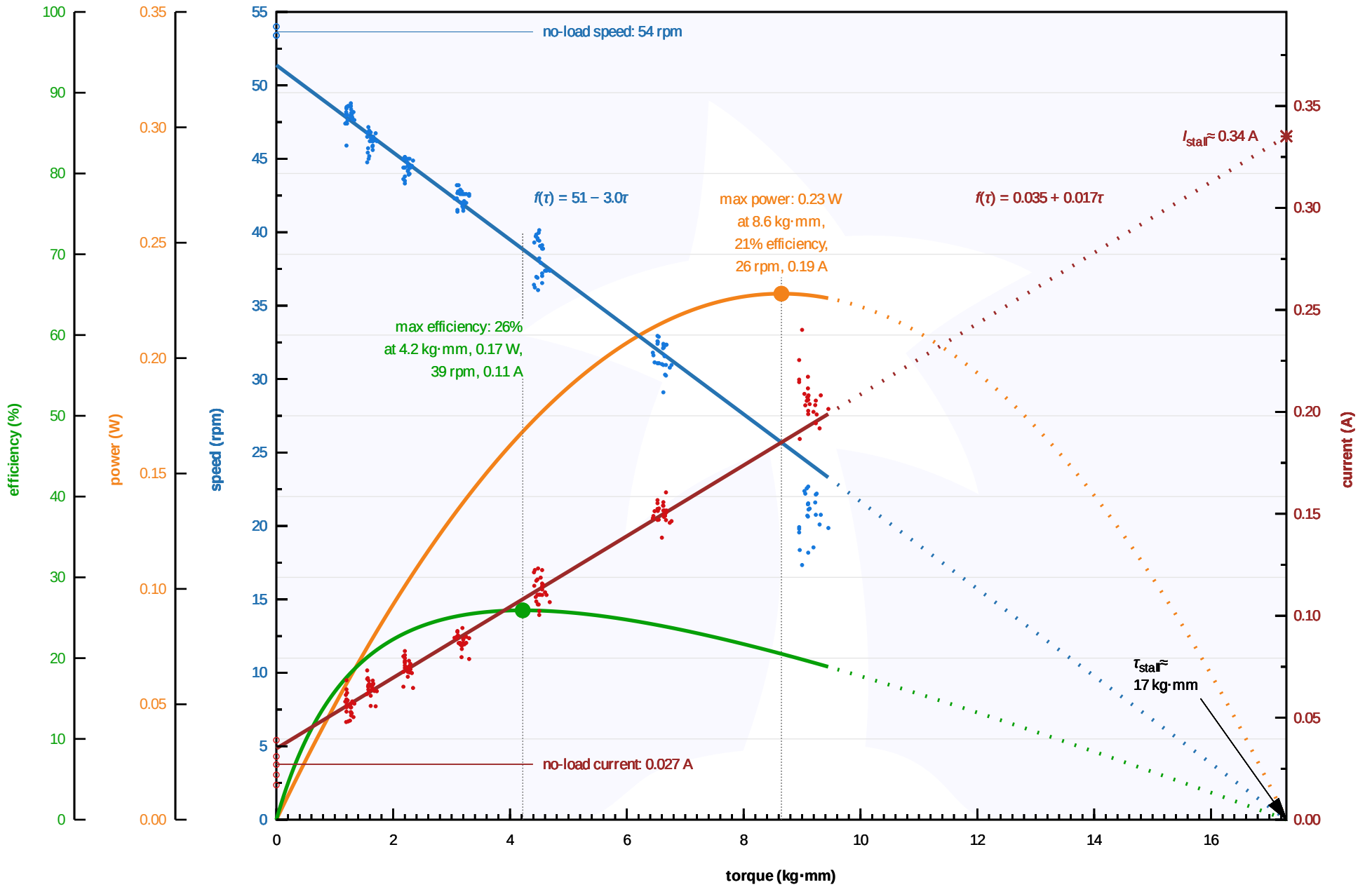

Pololu Items #1094, #2208 (298:1 Micro Metal Gearmotor LP 6V) Performance at 6 V

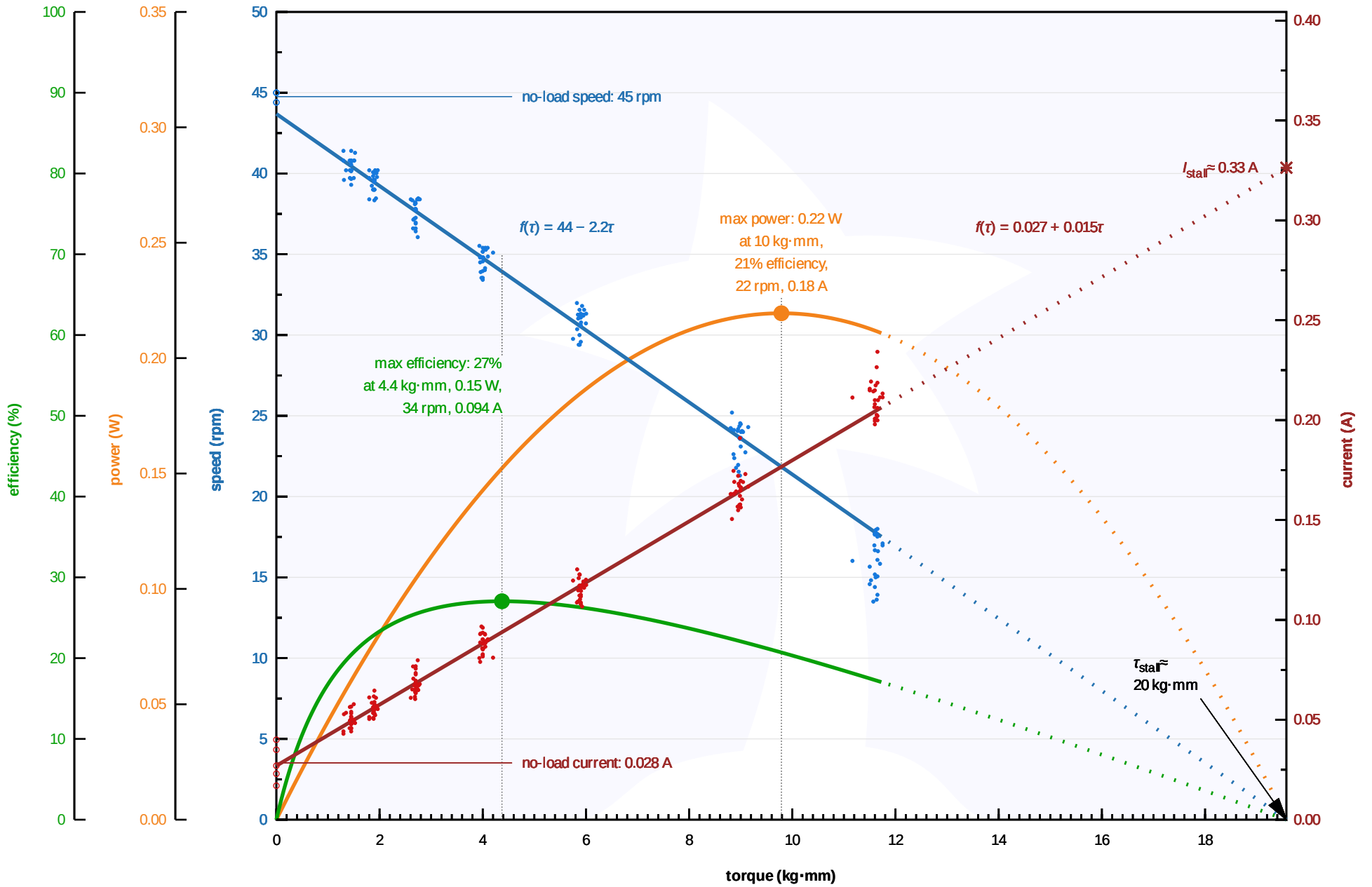

Pololu Items #4790, #4791 (380:1 Micro Metal Gearmotor LP 6V) Performance at 6 V

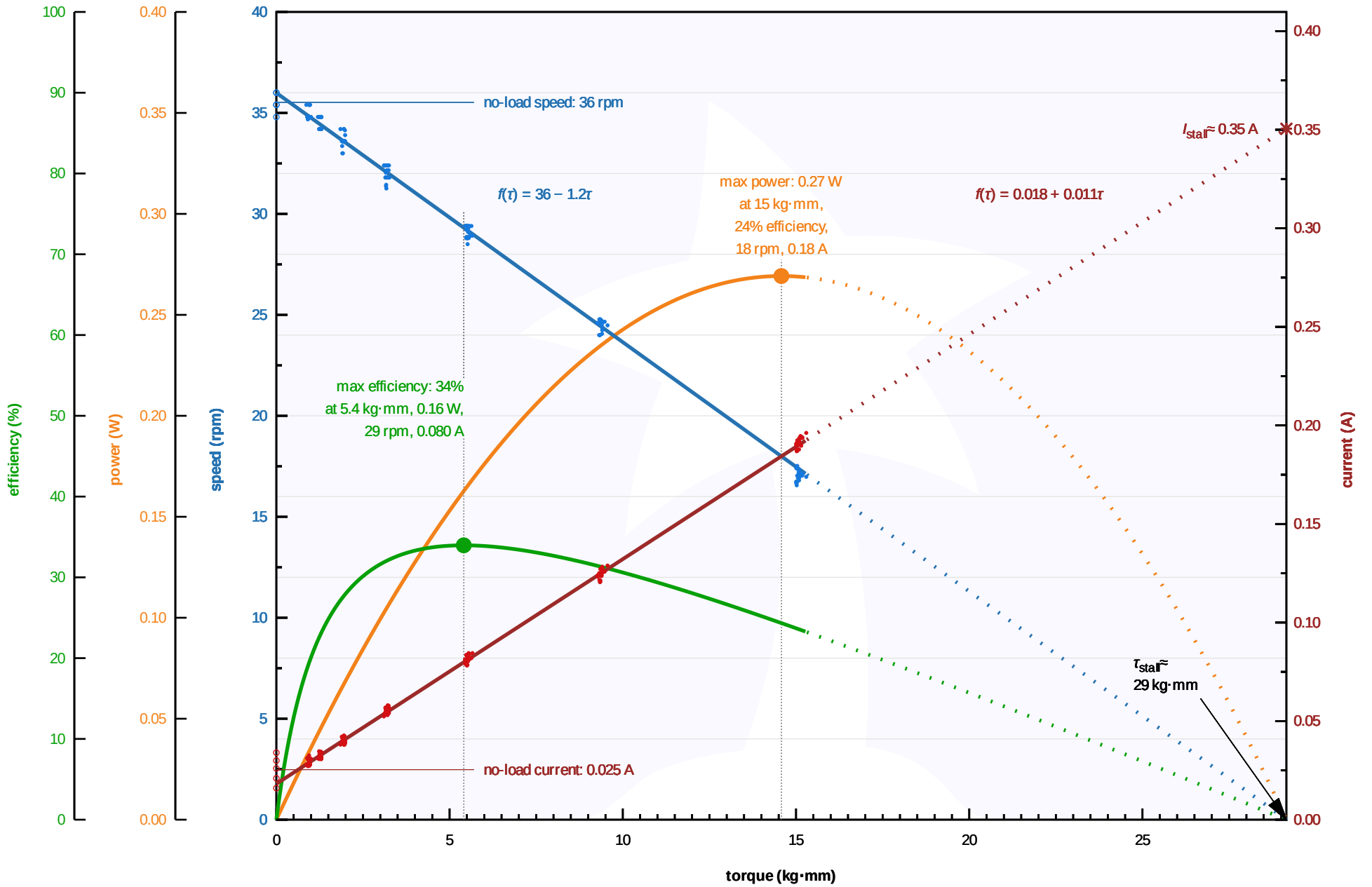

Pololu Items #1596, #3058 (1000:1 Micro Metal Gearmotor LP 6V) Performance at 6 V

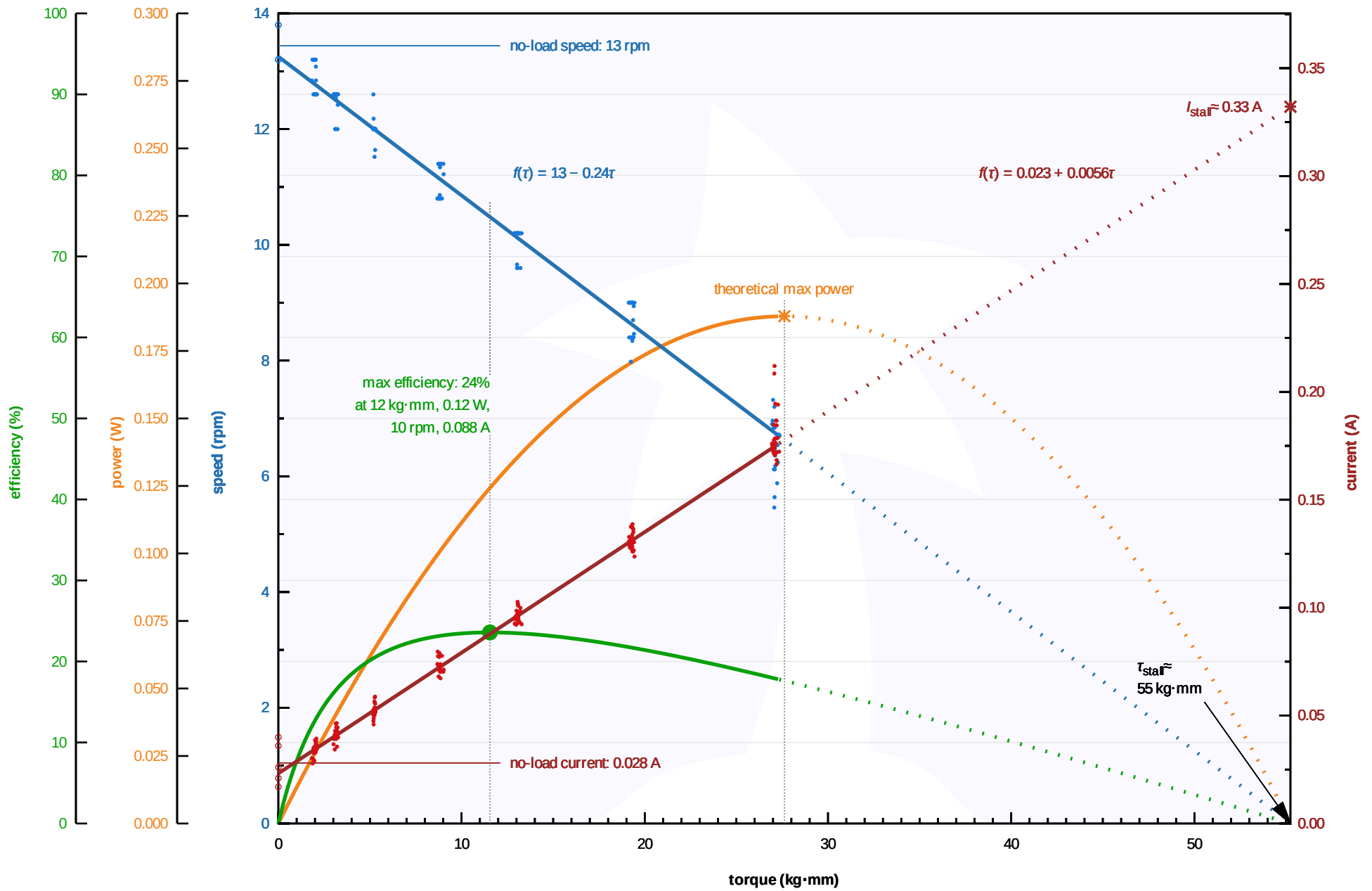

Pololu Items #4782, #4783 (15:1 Micro Metal Gearmotor MP 6V) Performance at 6 V

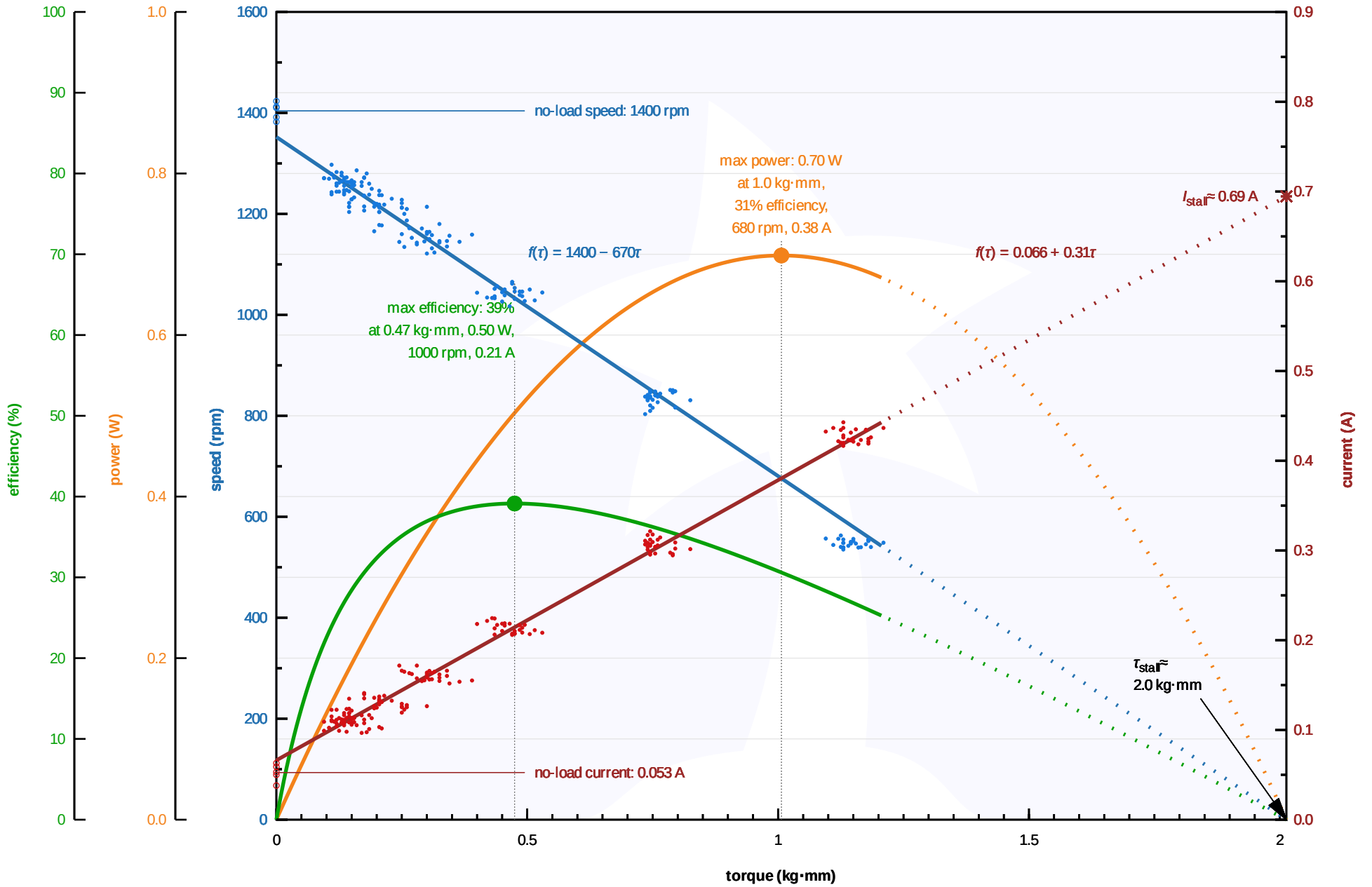

Pololu Items #2364, #2378 (30:1 Micro Metal Gearmotor MP 6V) Performance at 6 V

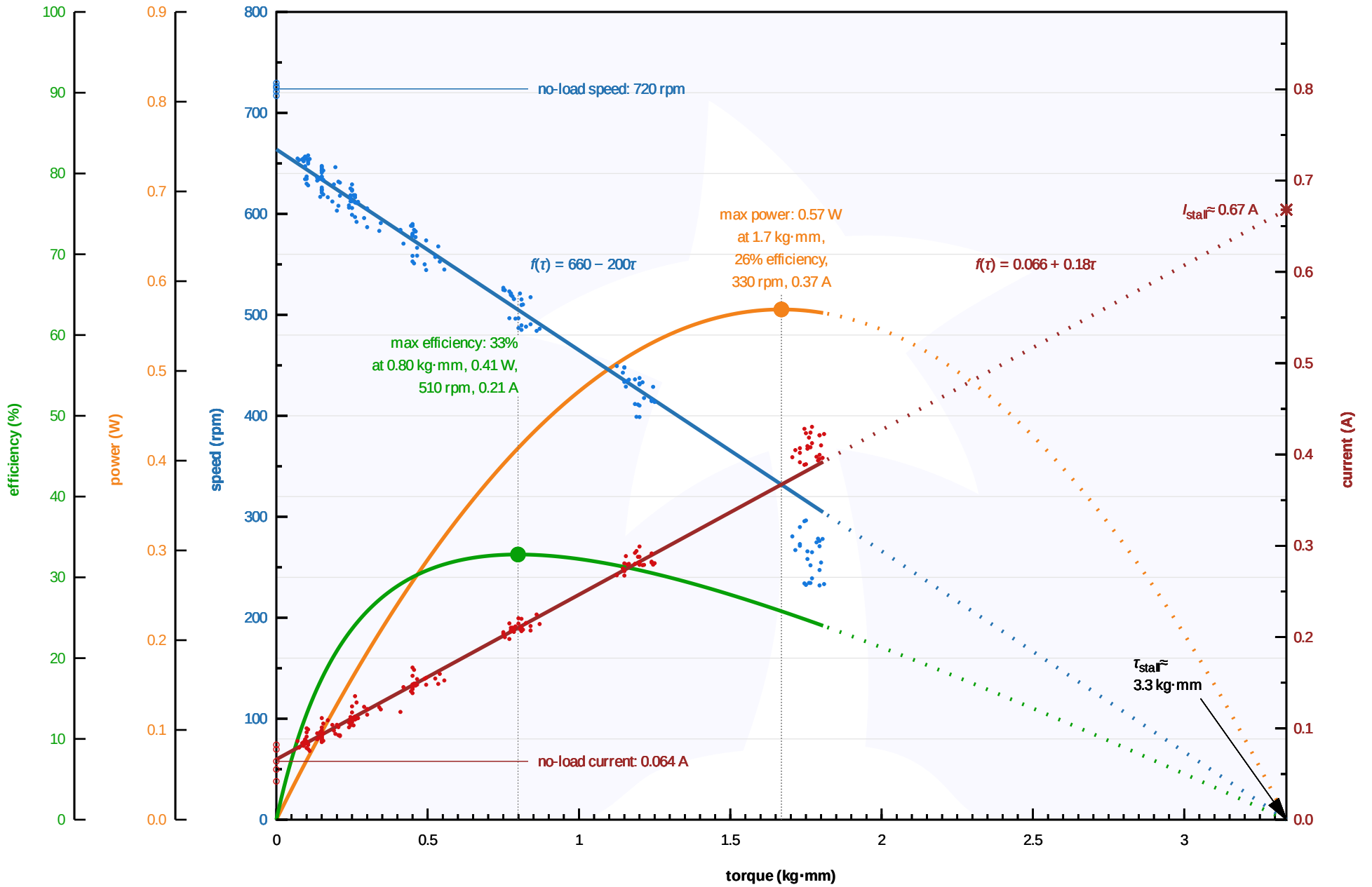

Pololu Items #2365, #2379 (50:1 Micro Metal Gearmotor MP 6V) Performance at 6 V

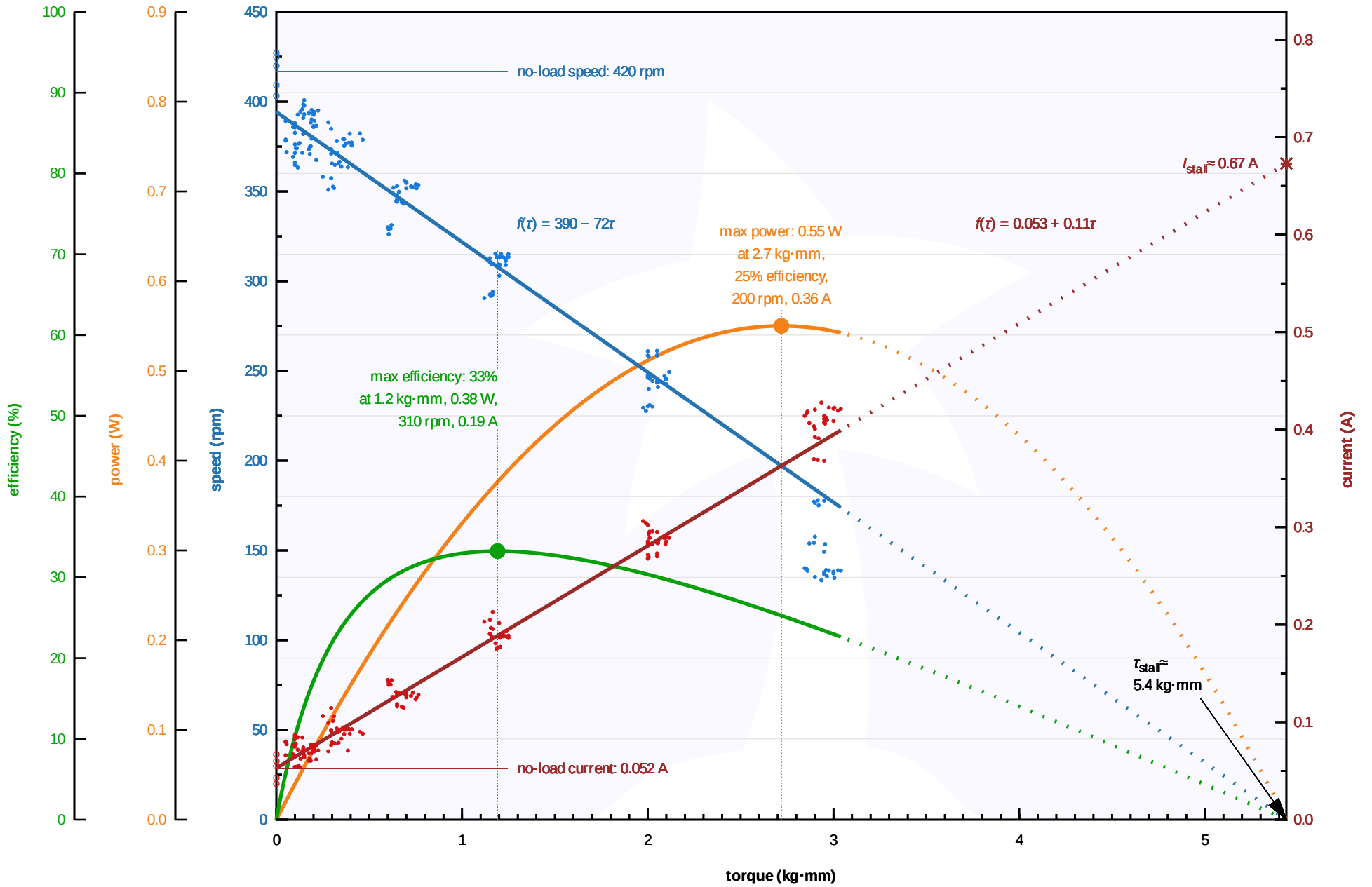

Pololu Items #2366, #2380 (75:1 Micro Metal Gearmotor MP 6V) Performance at 6 V

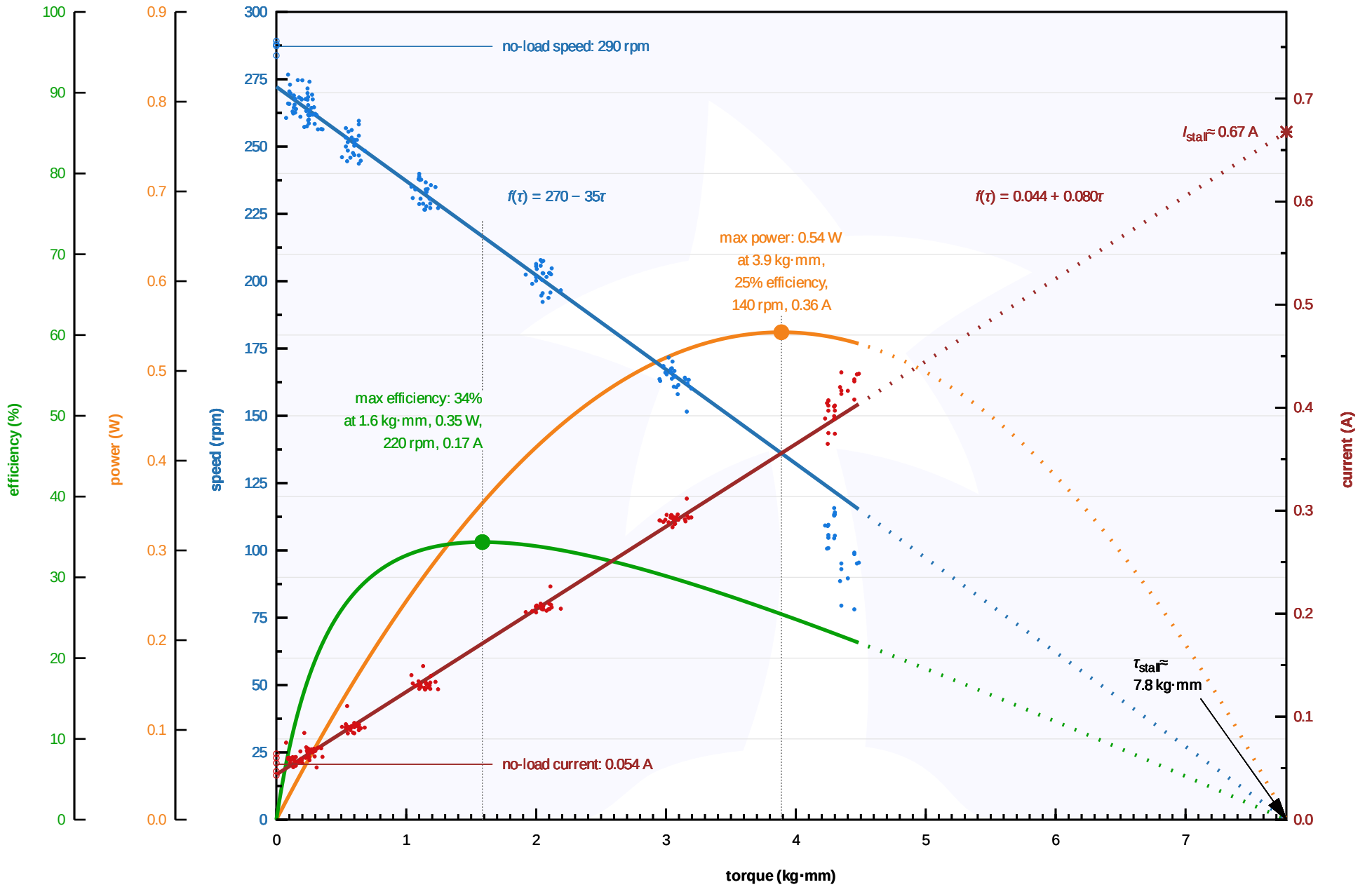

Pololu Items #2367, #2381 (100:1 Micro Metal Gearmotor MP 6V) Performance at 6 V

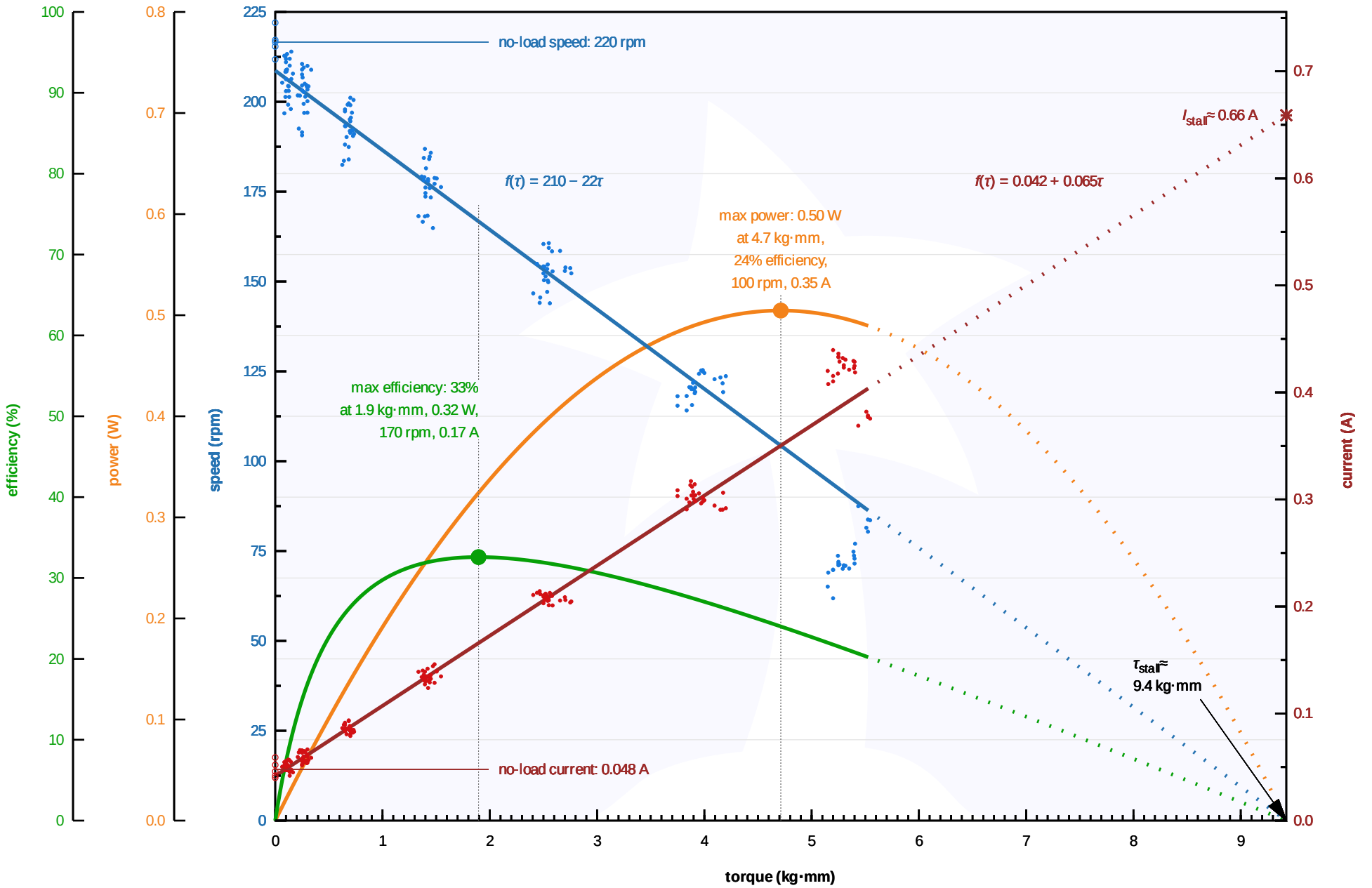

Pololu Items #2368, #2382 (150:1 Micro Metal Gearmotor MP 6V) Performance at 6 V

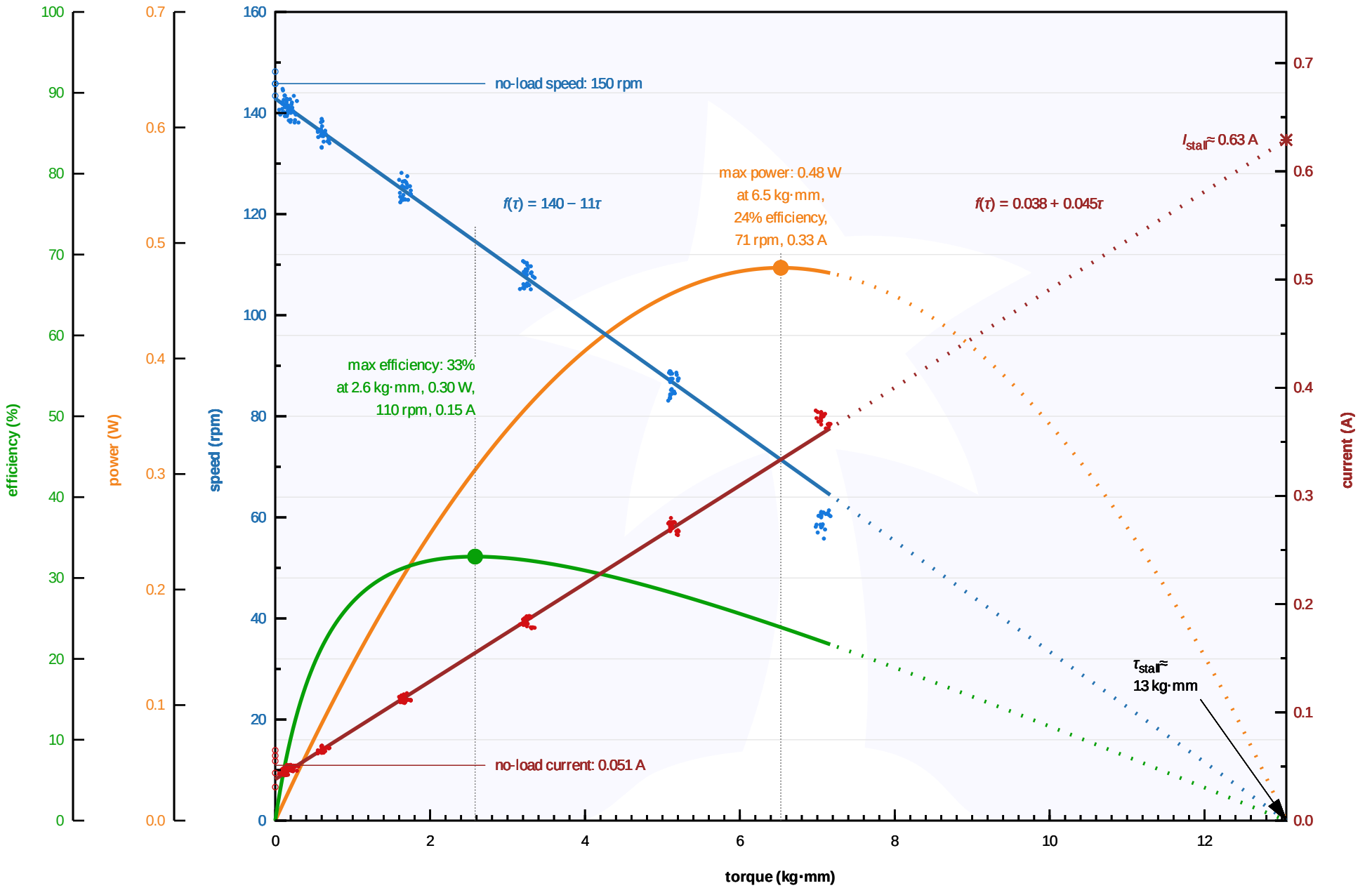

Pololu Items #2369, #2383 (210:1 Micro Metal Gearmotor MP 6V) Performance at 6 V

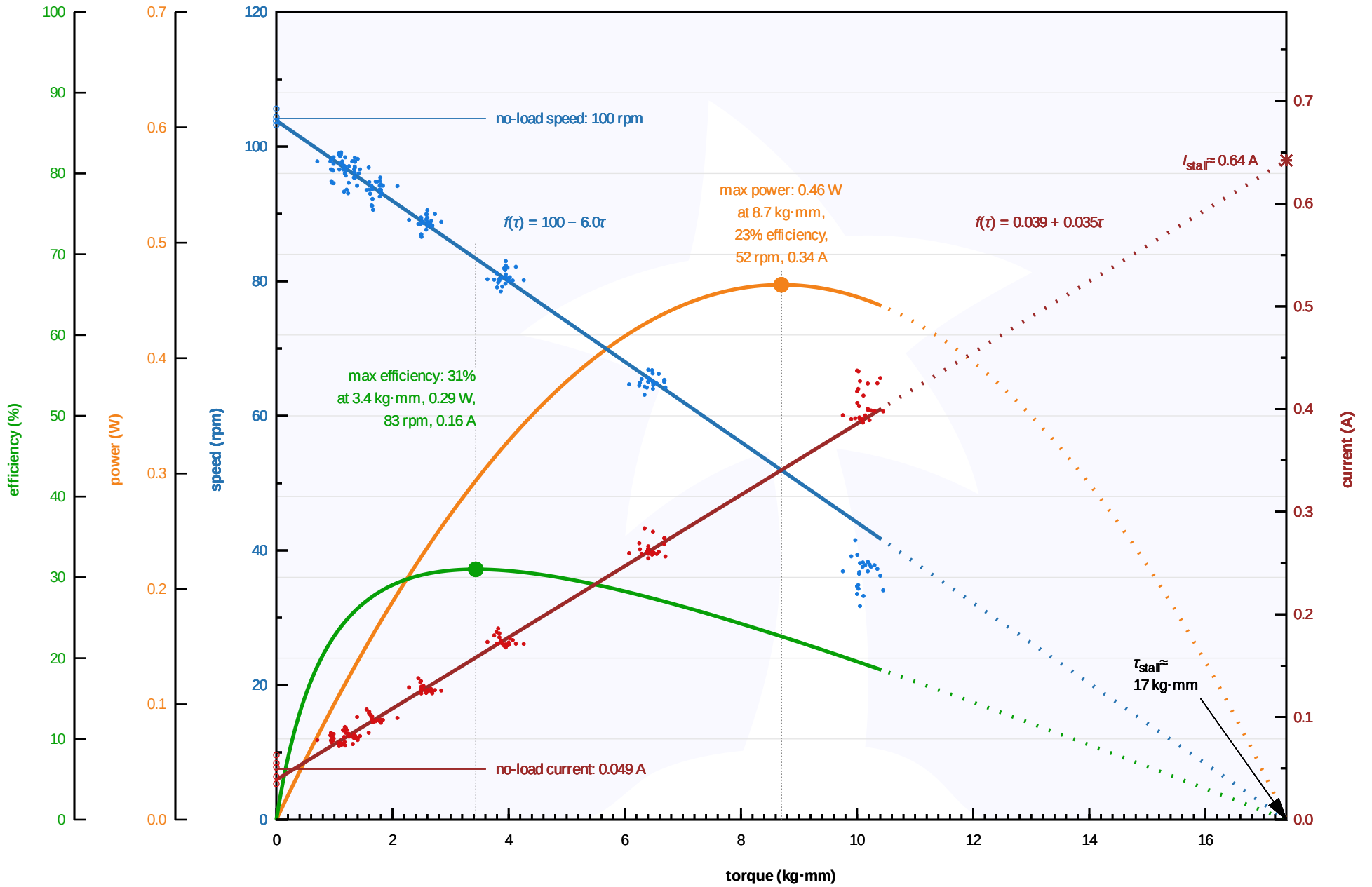

Pololu Items #2370, #2384 (250:1 Micro Metal Gearmotor MP 6V) Performance at 6 V

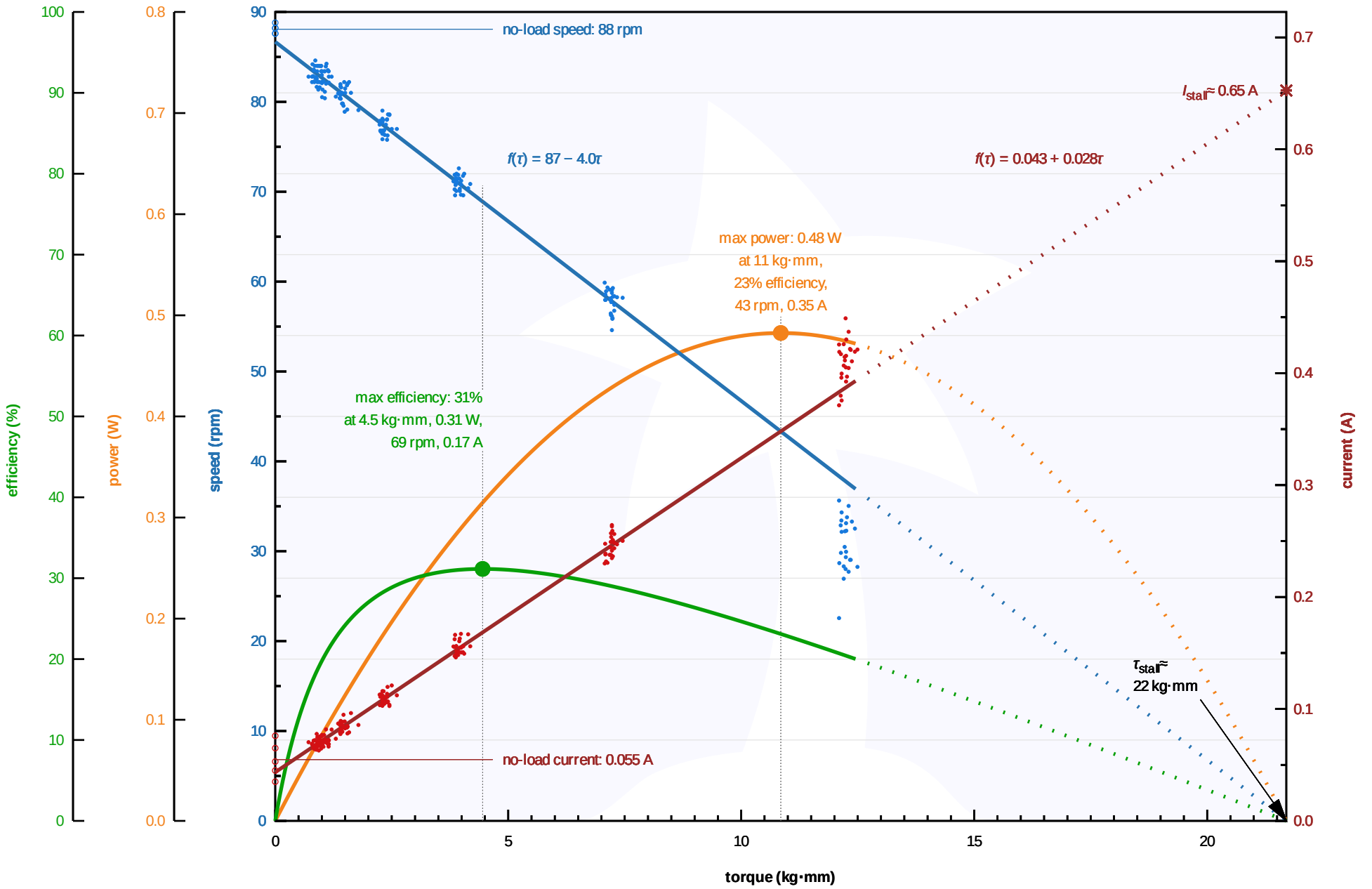

Pololu Items #2371, #2385 (298:1 Micro Metal Gearmotor MP 6V) Performance at 6 V

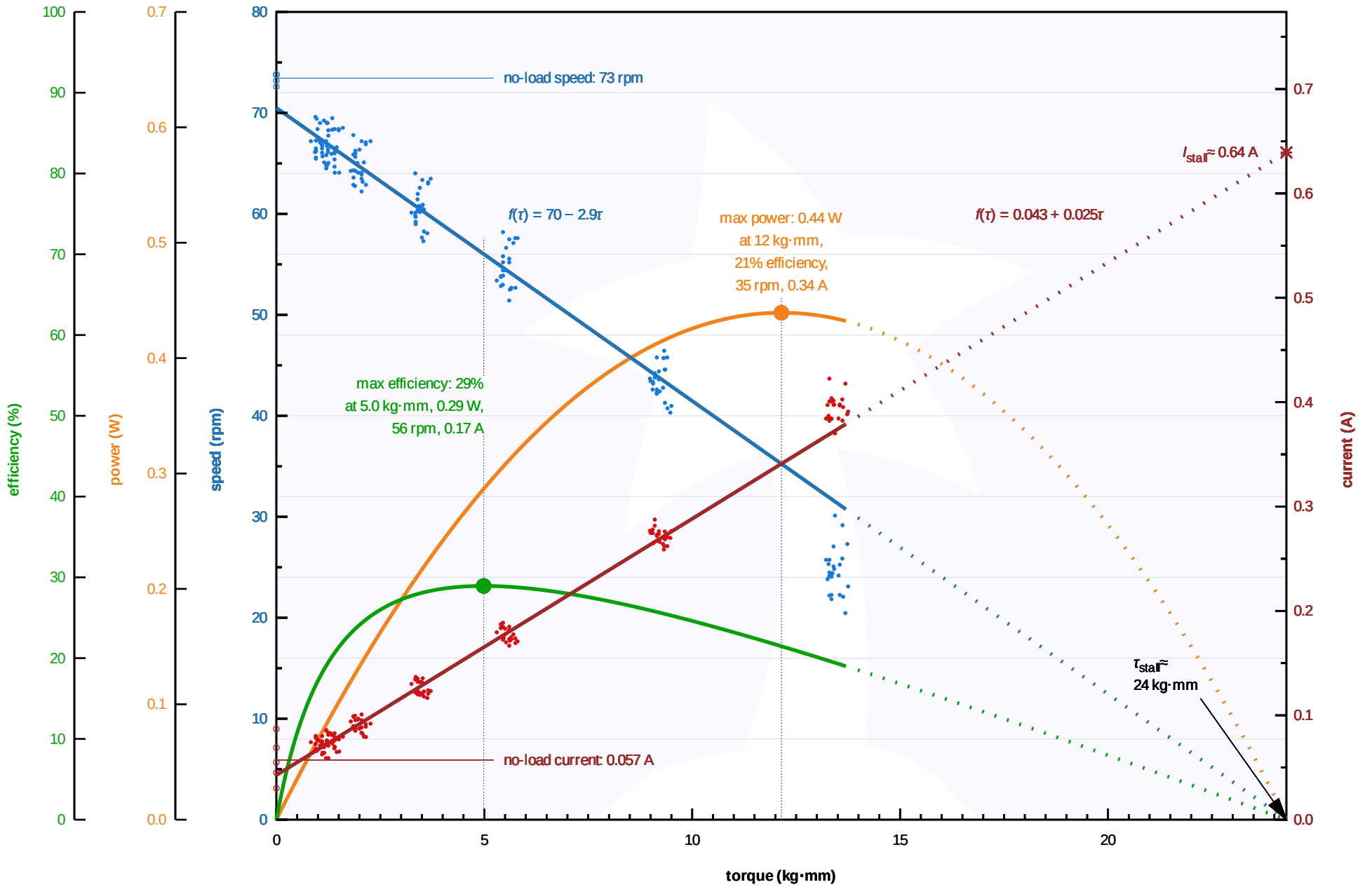

Pololu Items #4792, #4793 (380:1 Micro Metal Gearmotor MP 6V) Performance at 6 V

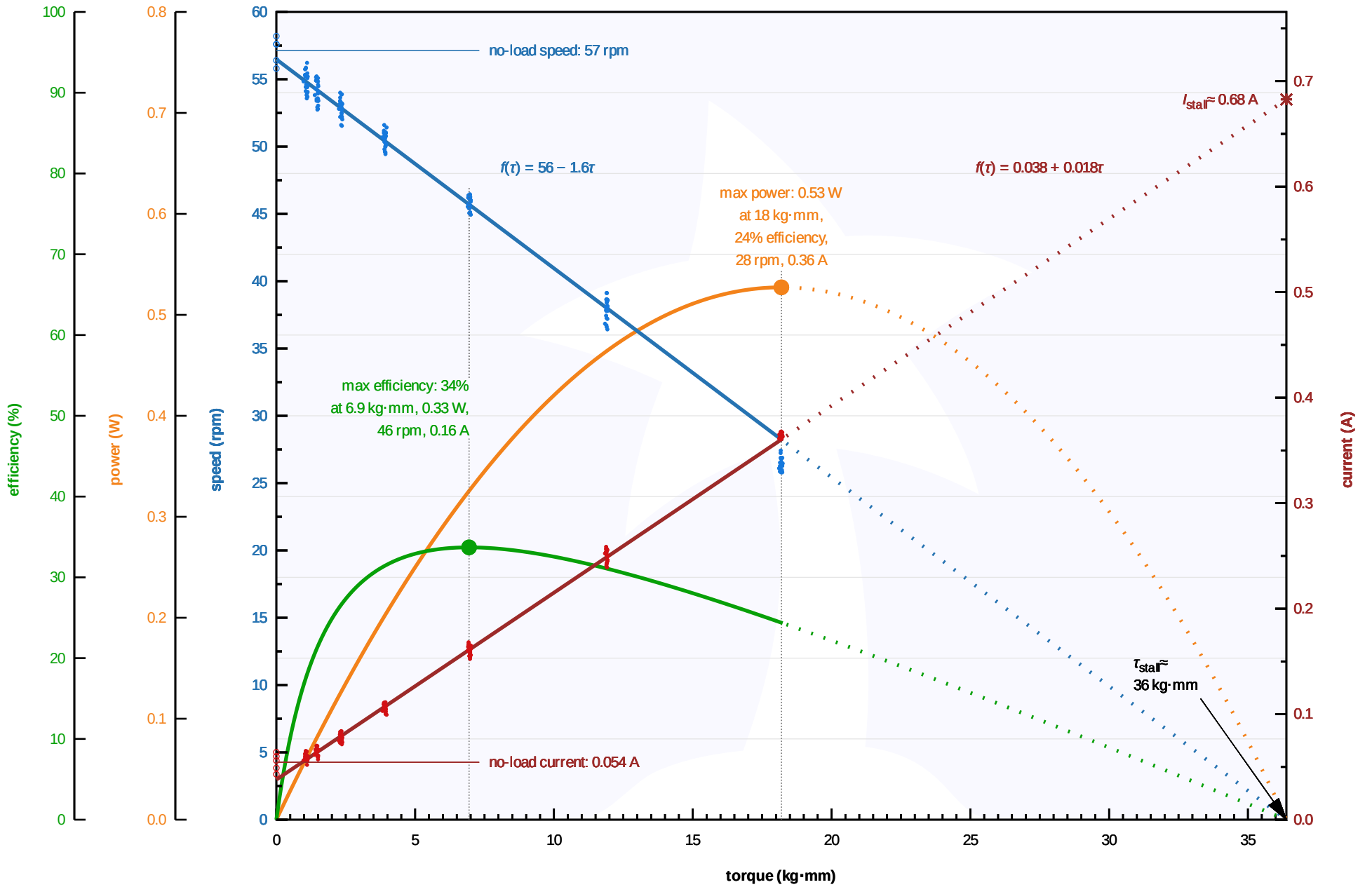

Pololu Items #2372, #3059 (1000:1 Micro Metal Gearmotor MP 6V) Performance at 6 V

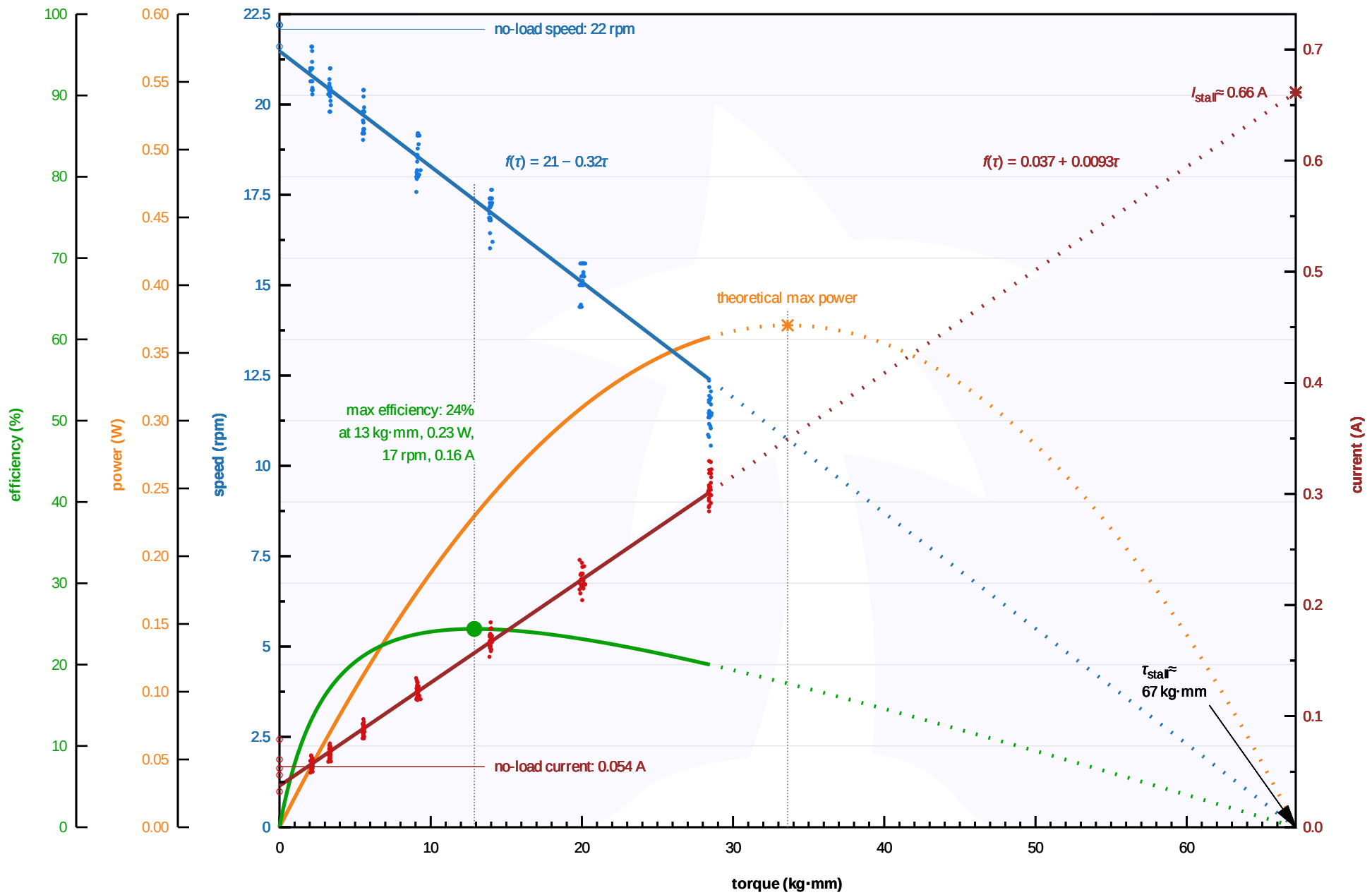

Pololu Items #999, #2211 (10:1 Micro Metal Gearmotor HP 6V) Performance at 6 V

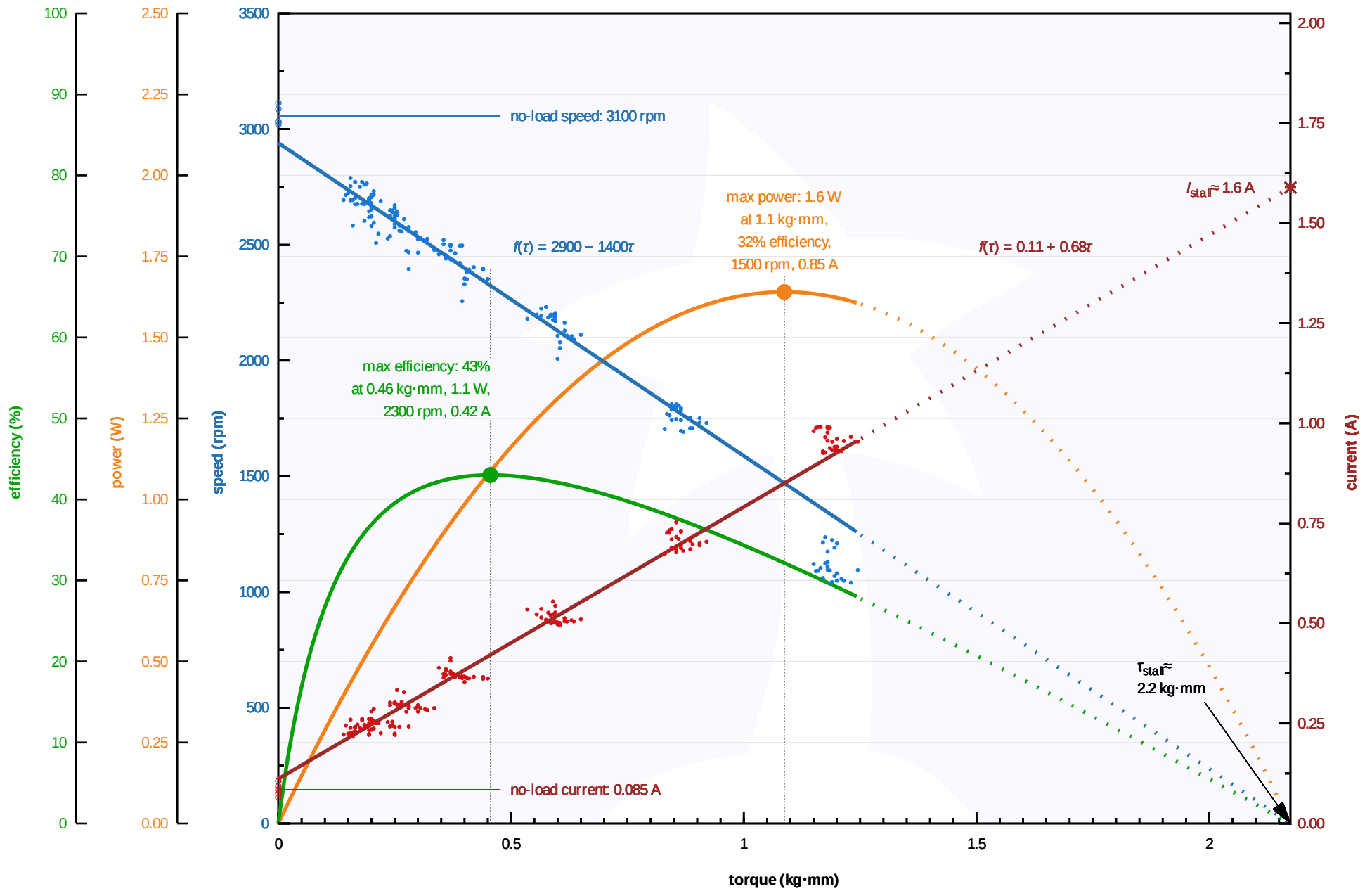

Pololu Items #4784, #4785 (15:1 Micro Metal Gearmotor HP 6V) Performance at 6 V

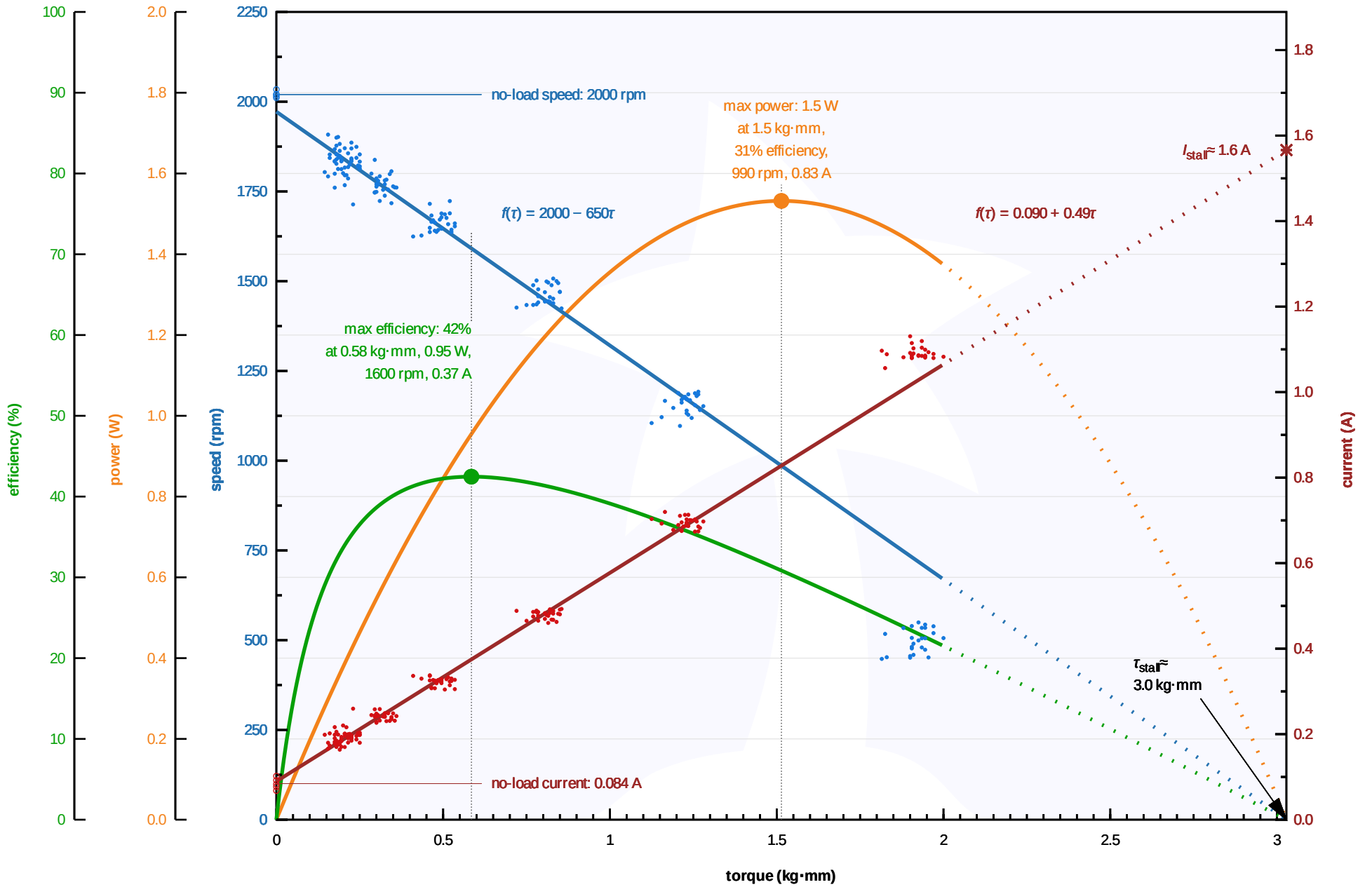

Pololu Items #1093, #2212 (30:1 Micro Metal Gearmotor HP 6V) Performance at 6 V

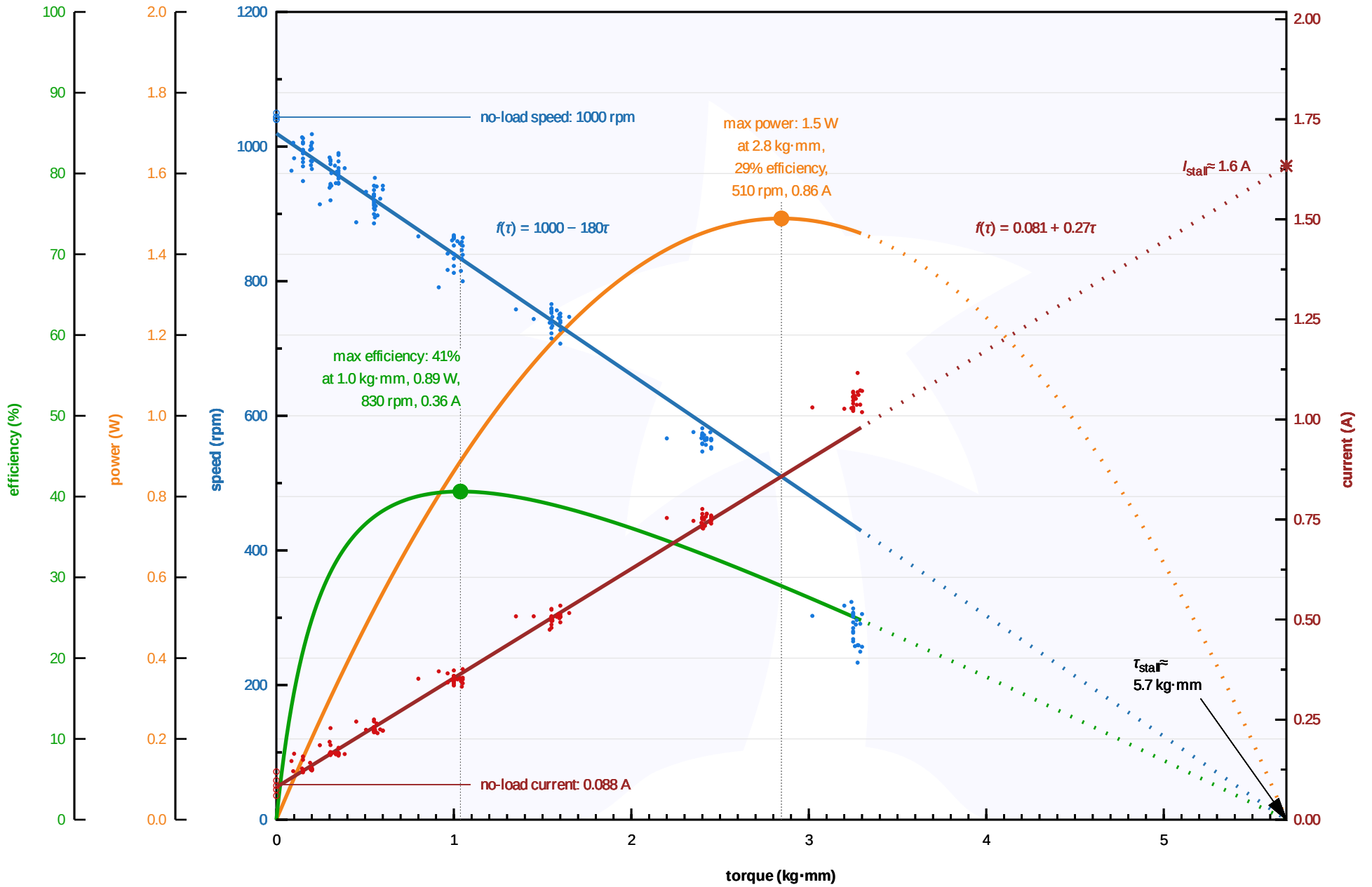

Pololu Items #998, #2213 (50:1 Micro Metal Gearmotor HP 6V) Performance at 6 V

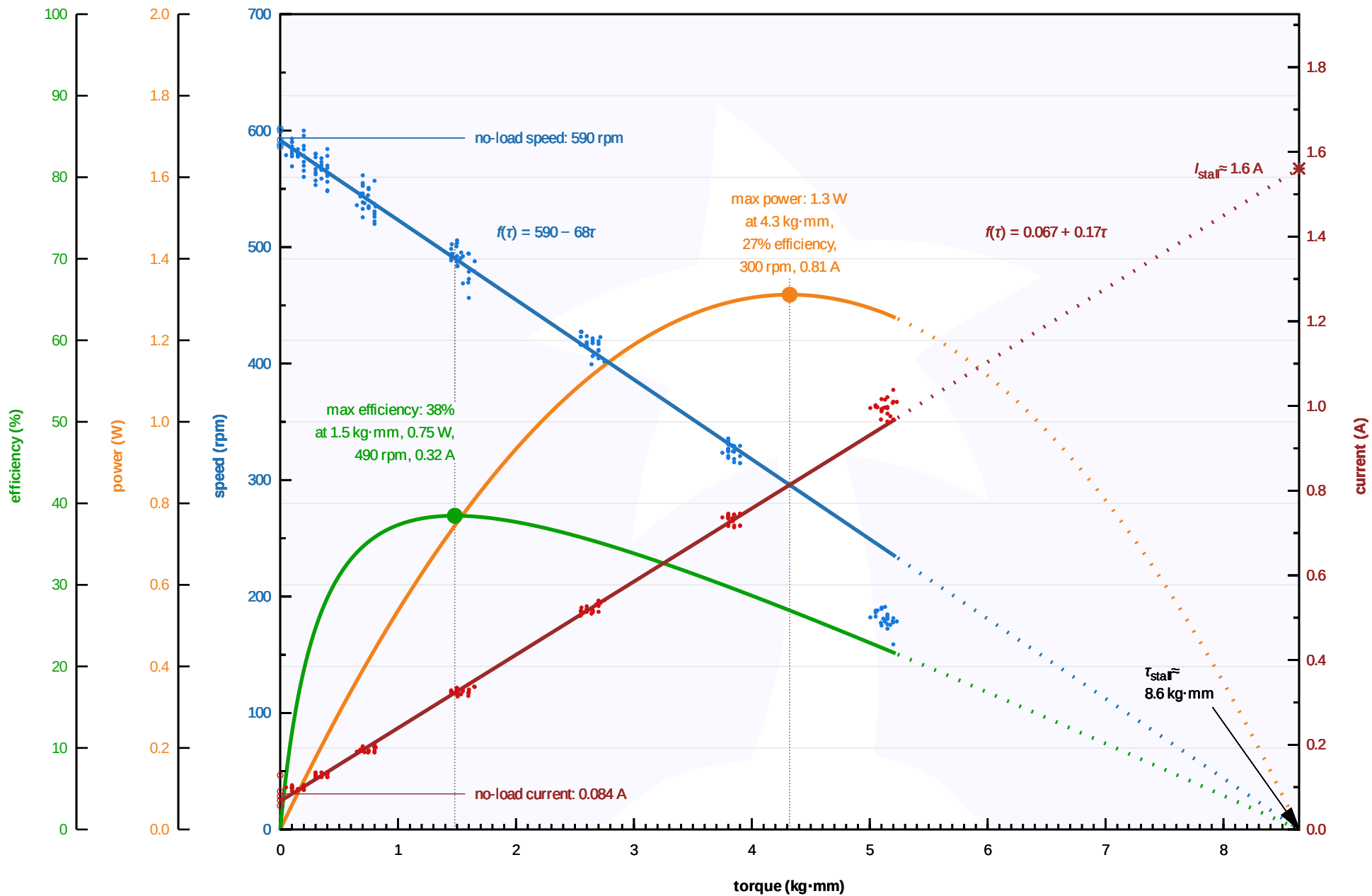

Pololu Items #2361, #2215 (75:1 Micro Metal Gearmotor HP 6V) Performance at 6 V

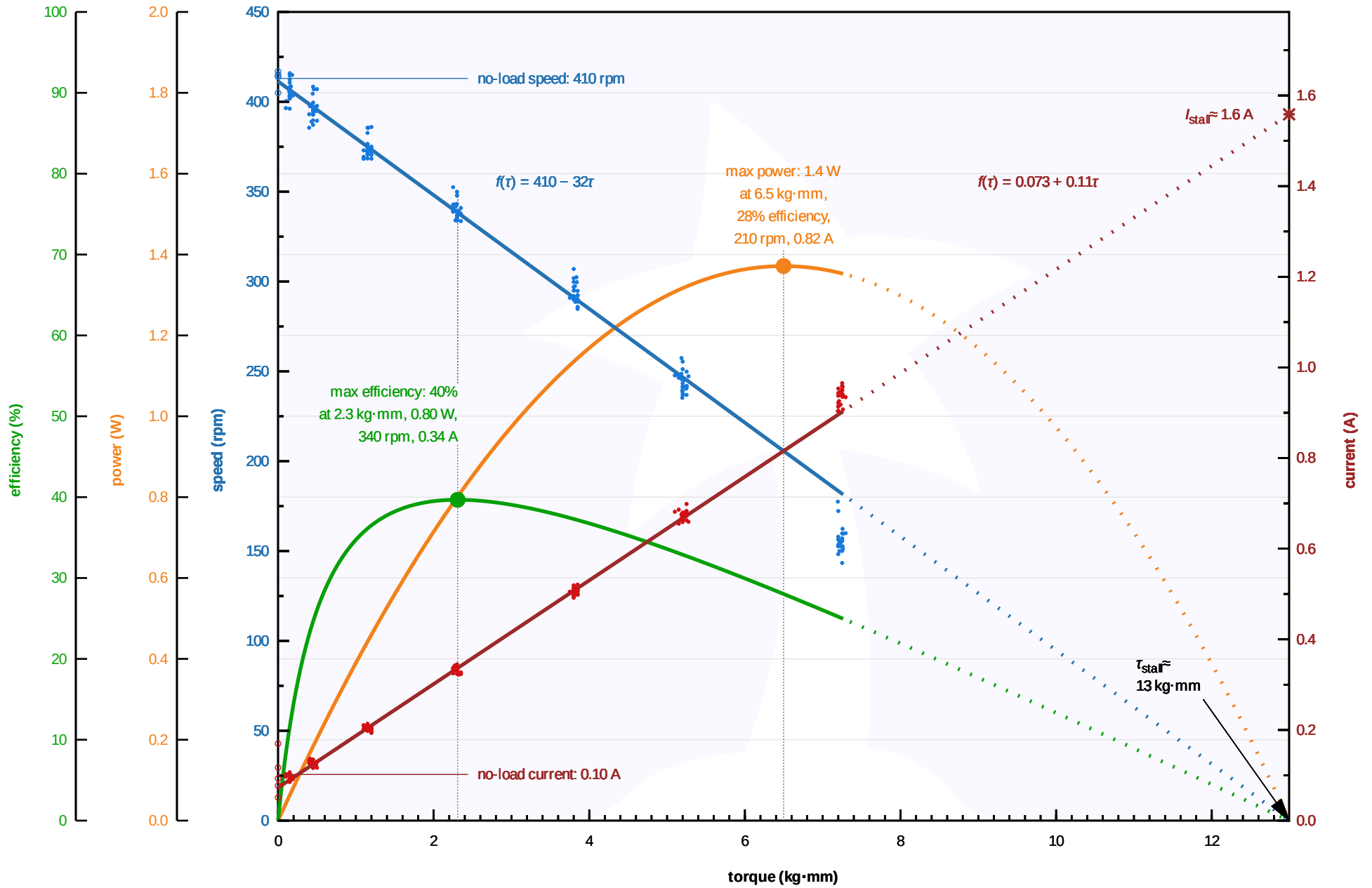

Pololu Items #1101, #2214 (100:1 Micro Metal Gearmotor HP 6V) Performance at 6 V

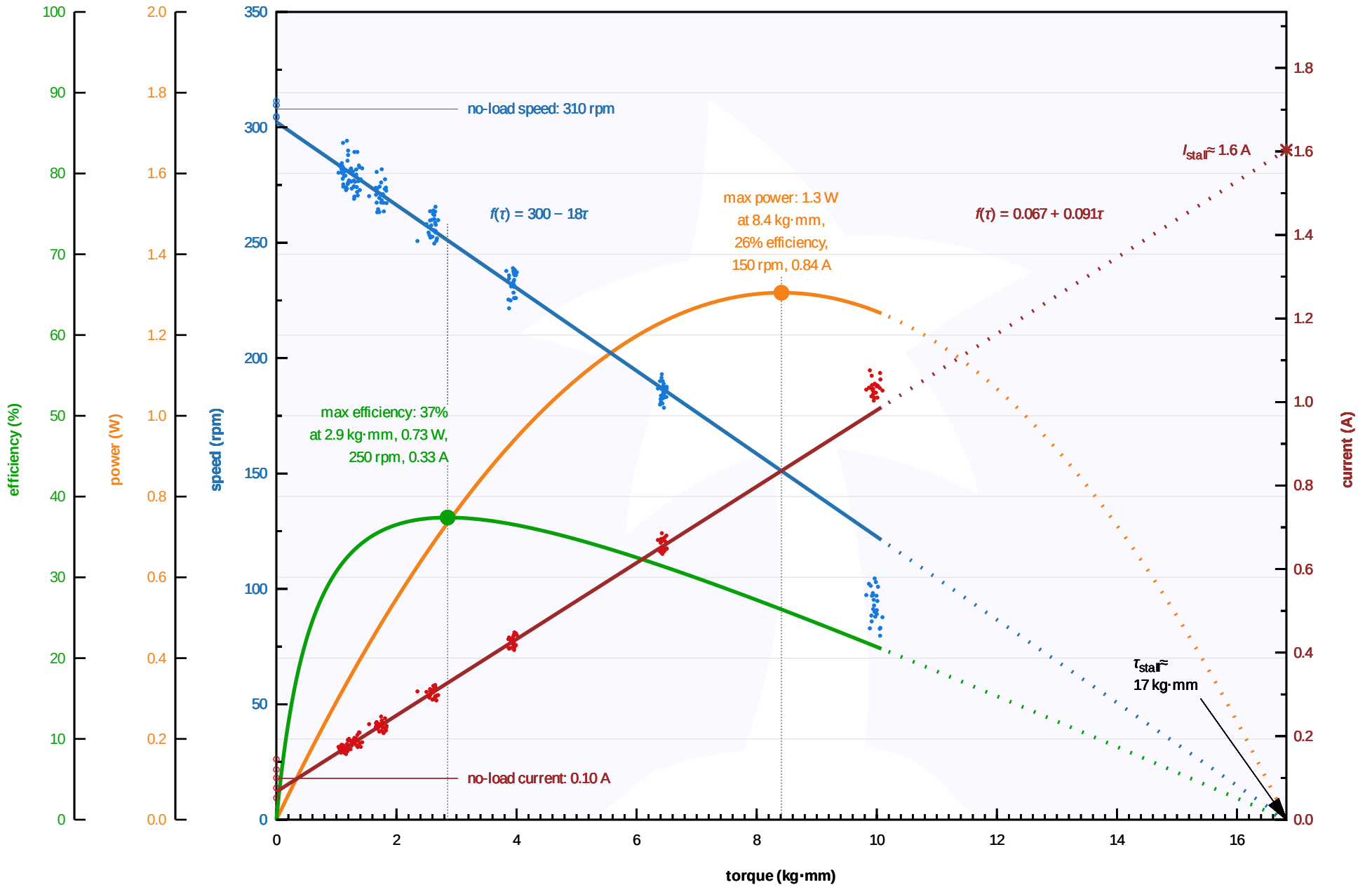

Pololu Items #997, #2386 (150:1 Micro Metal Gearmotor HP 6V) Performance at 6 V

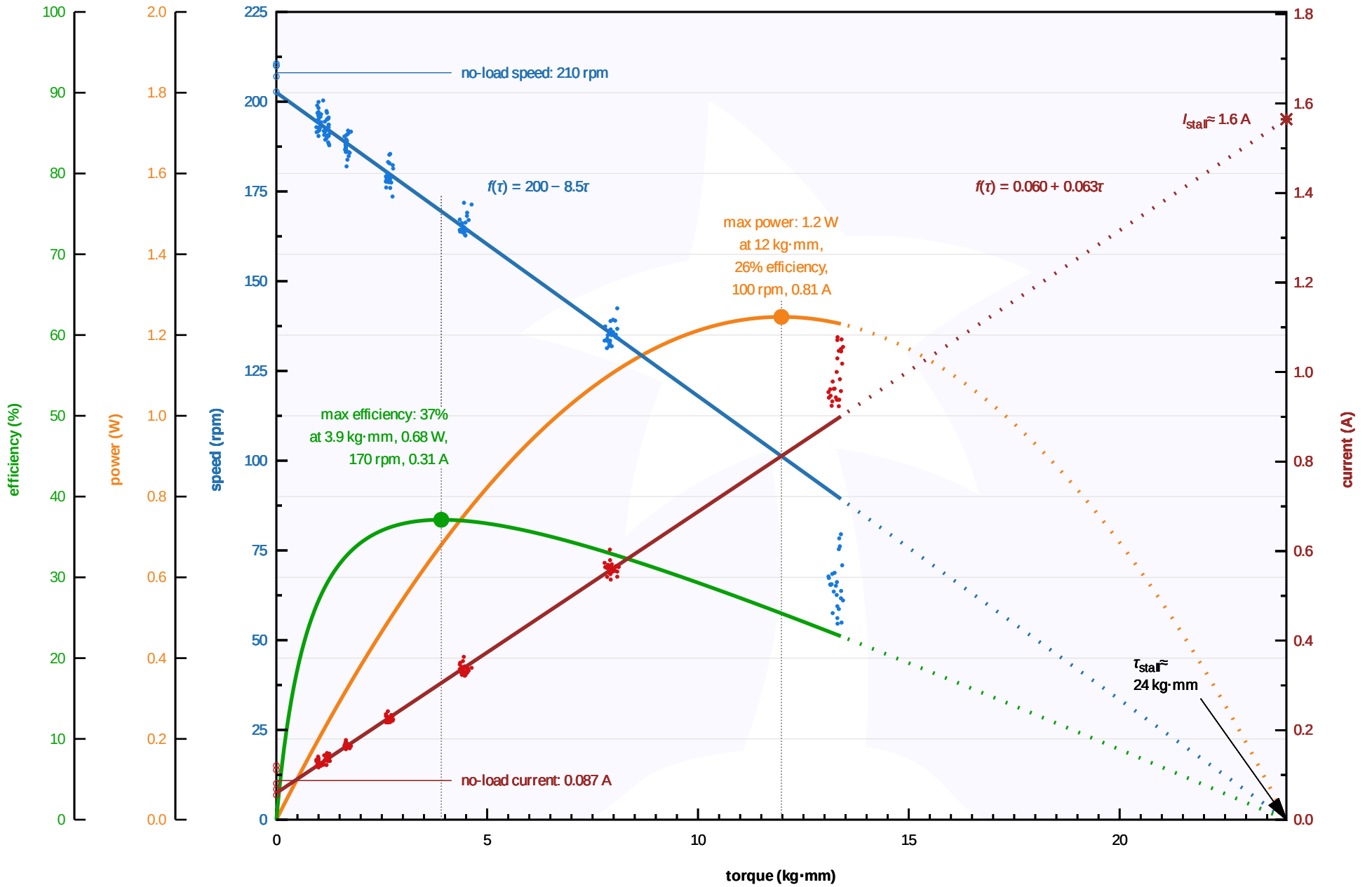

Pololu Items #996, #2216 (210:1 Micro Metal Gearmotor HP 6V) Performance at 6 V

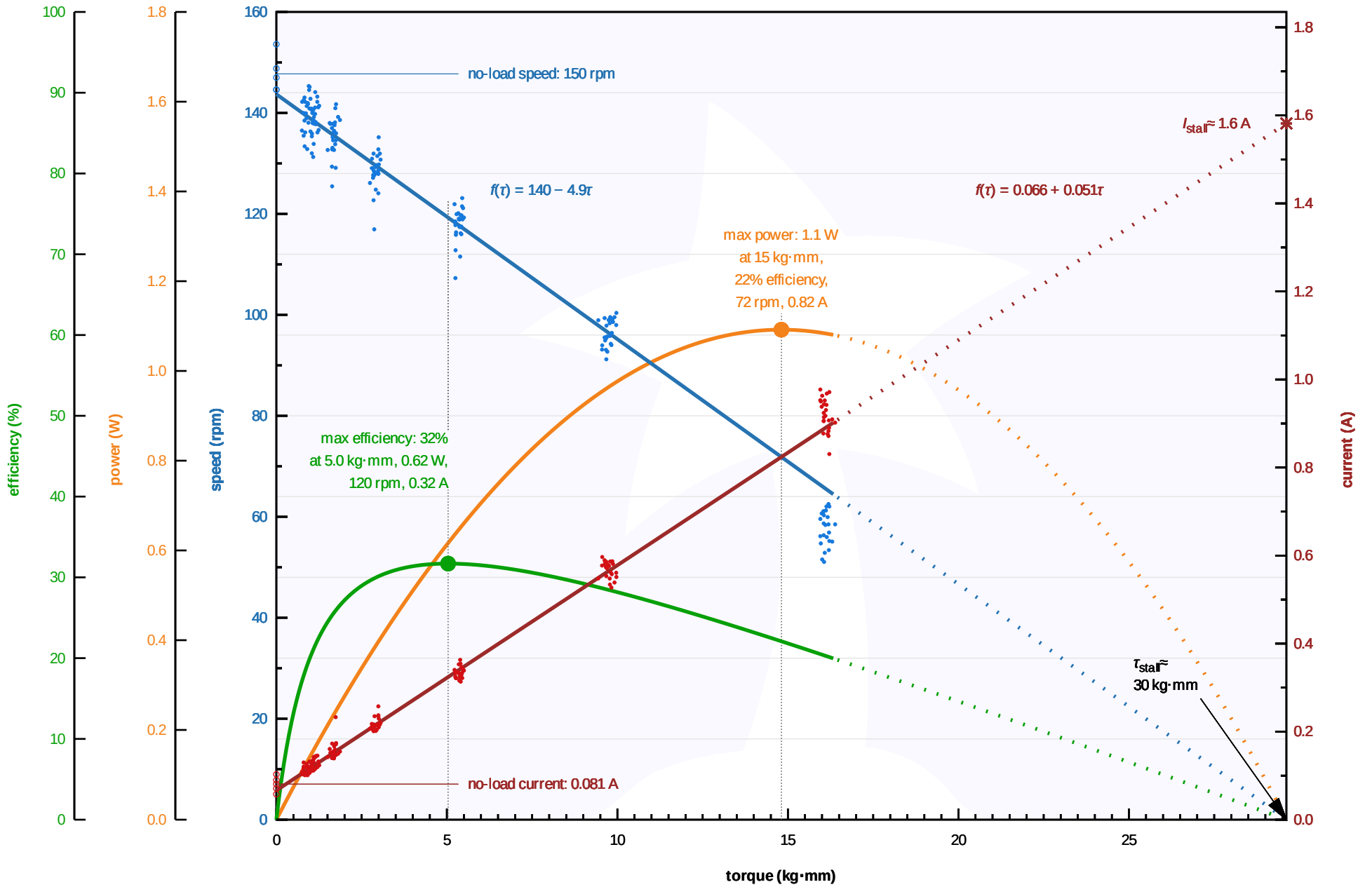

Pololu Items #995, #2217 (250:1 Micro Metal Gearmotor HP 6V) Performance at 6 V

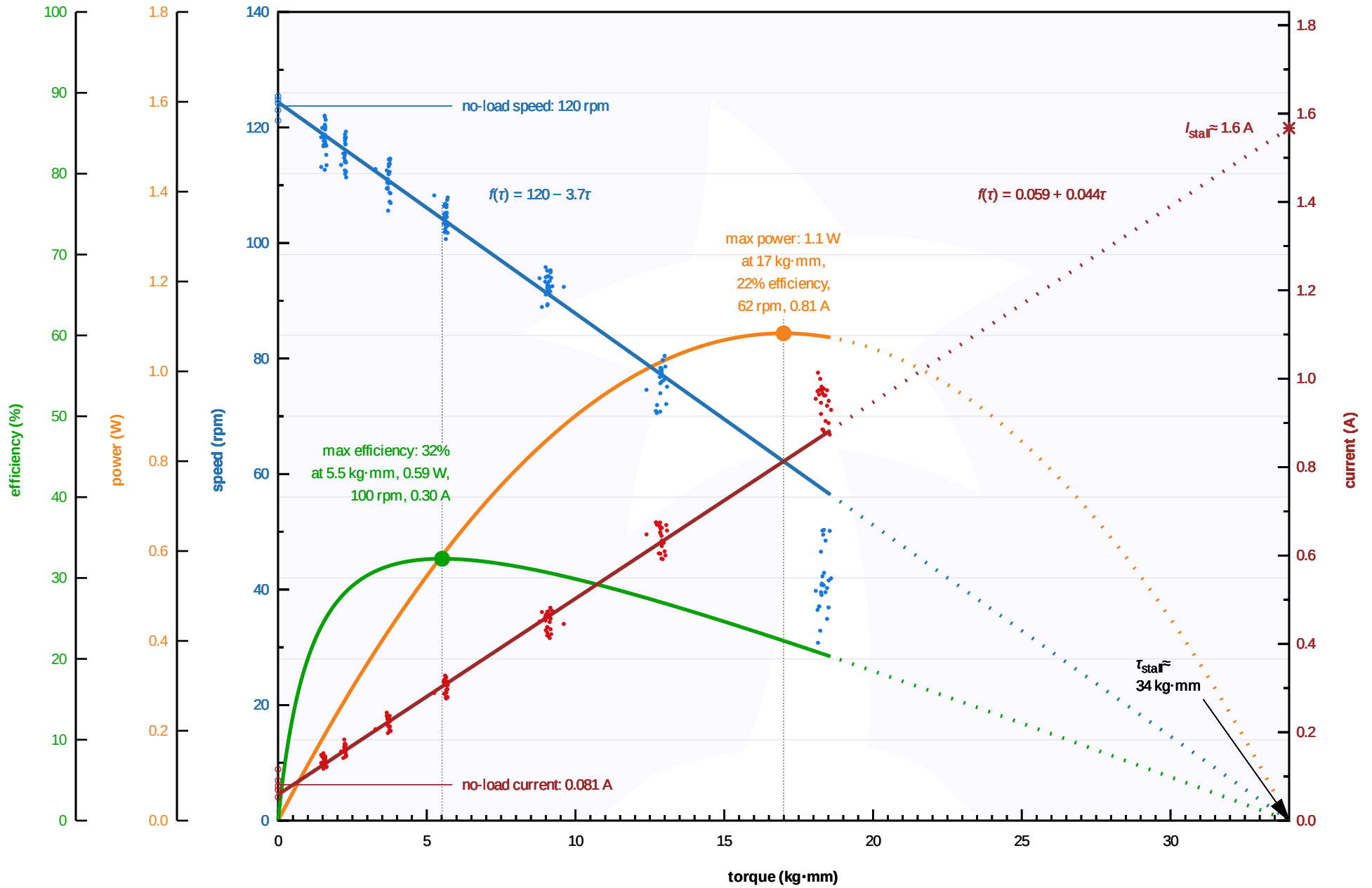

Pololu Items #994, #2218 (298:1 Micro Metal Gearmotor HP 6V) Performance at 6 V

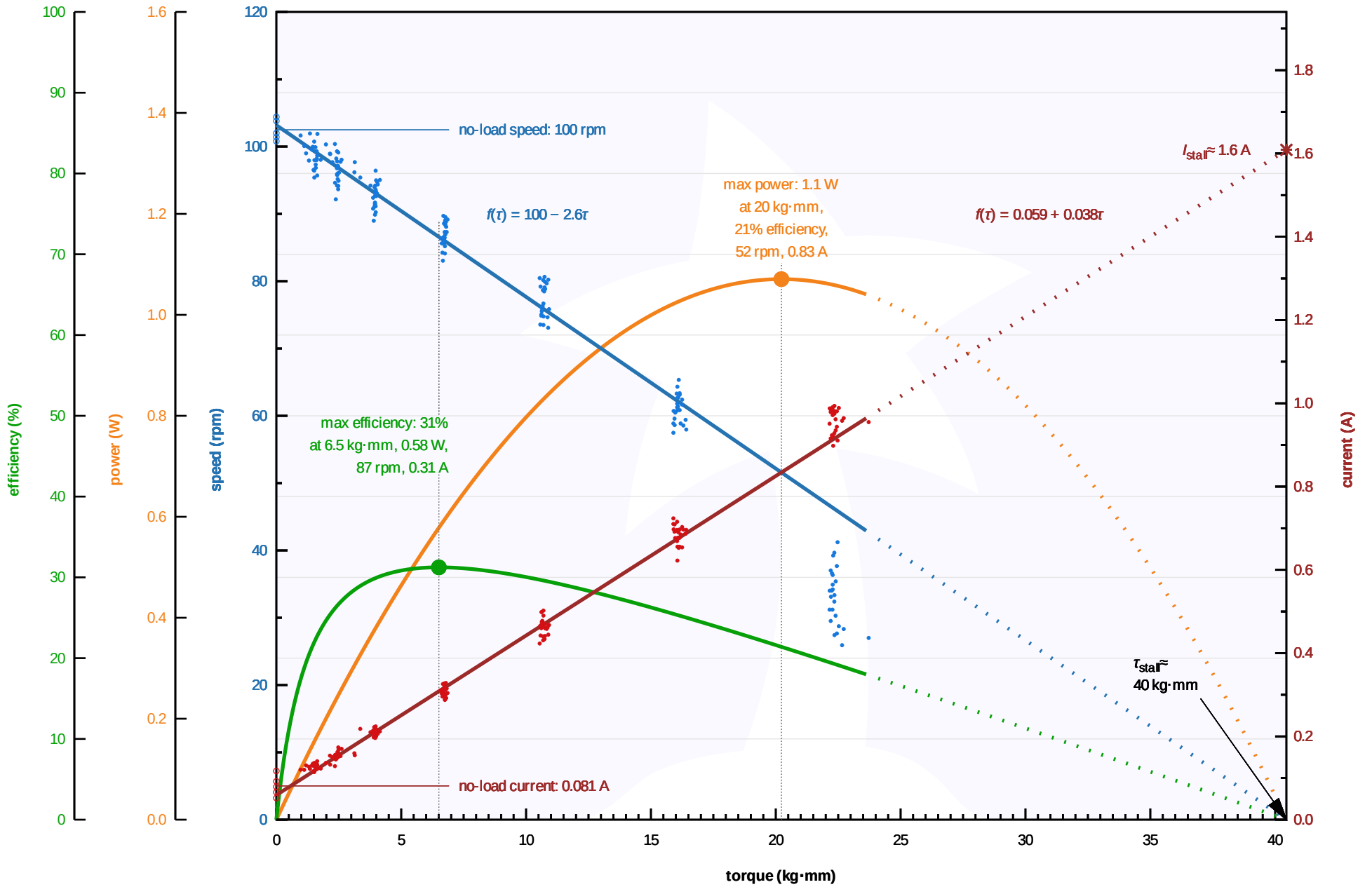

Pololu Items #4794, #4795 (380:1 Micro Metal Gearmotor HP 6V) Performance at 6 V

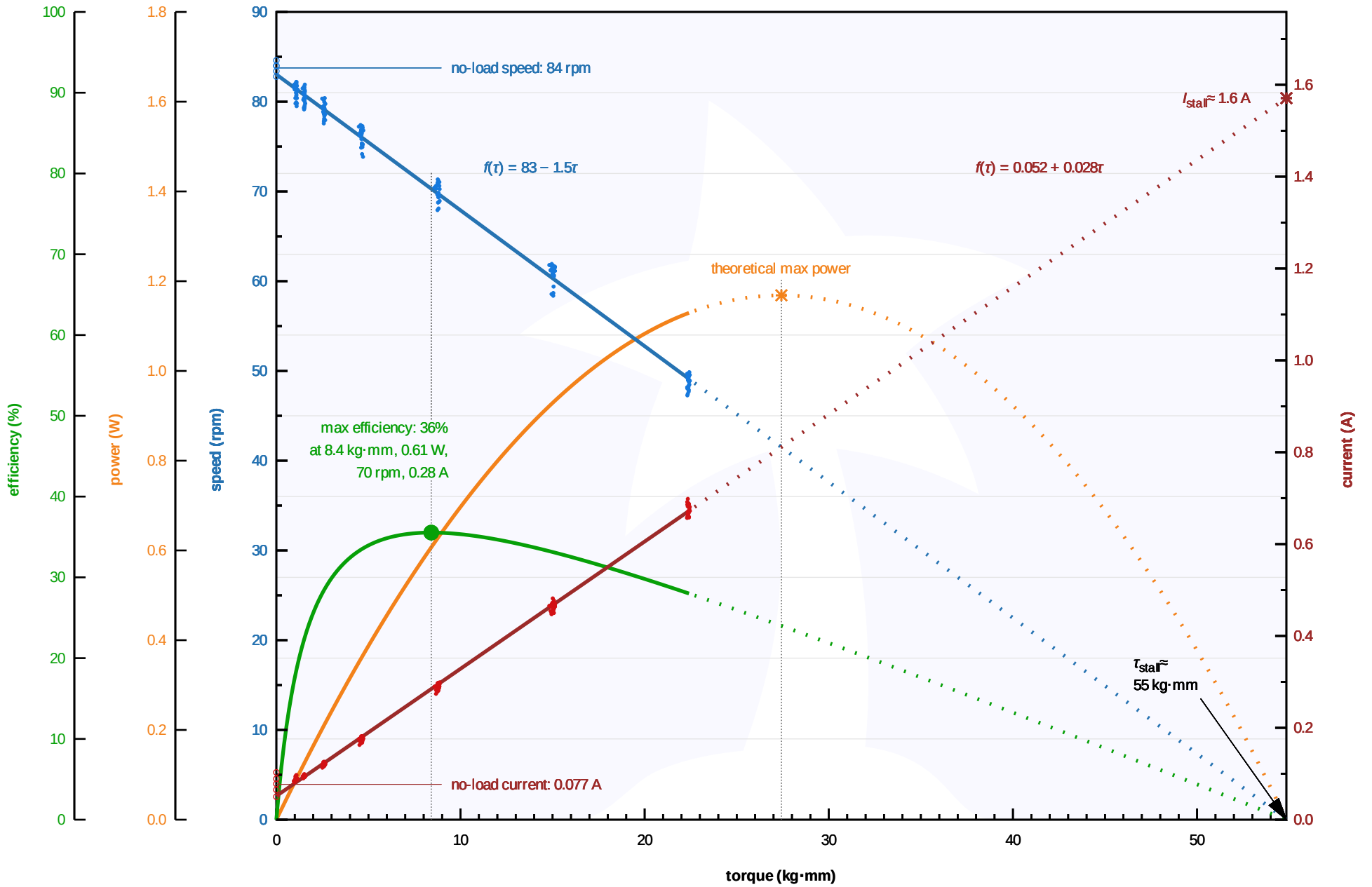

Pololu Items #1595, #2373 (1000:1 Micro Metal Gearmotor HP 6V) Performance at 6 V

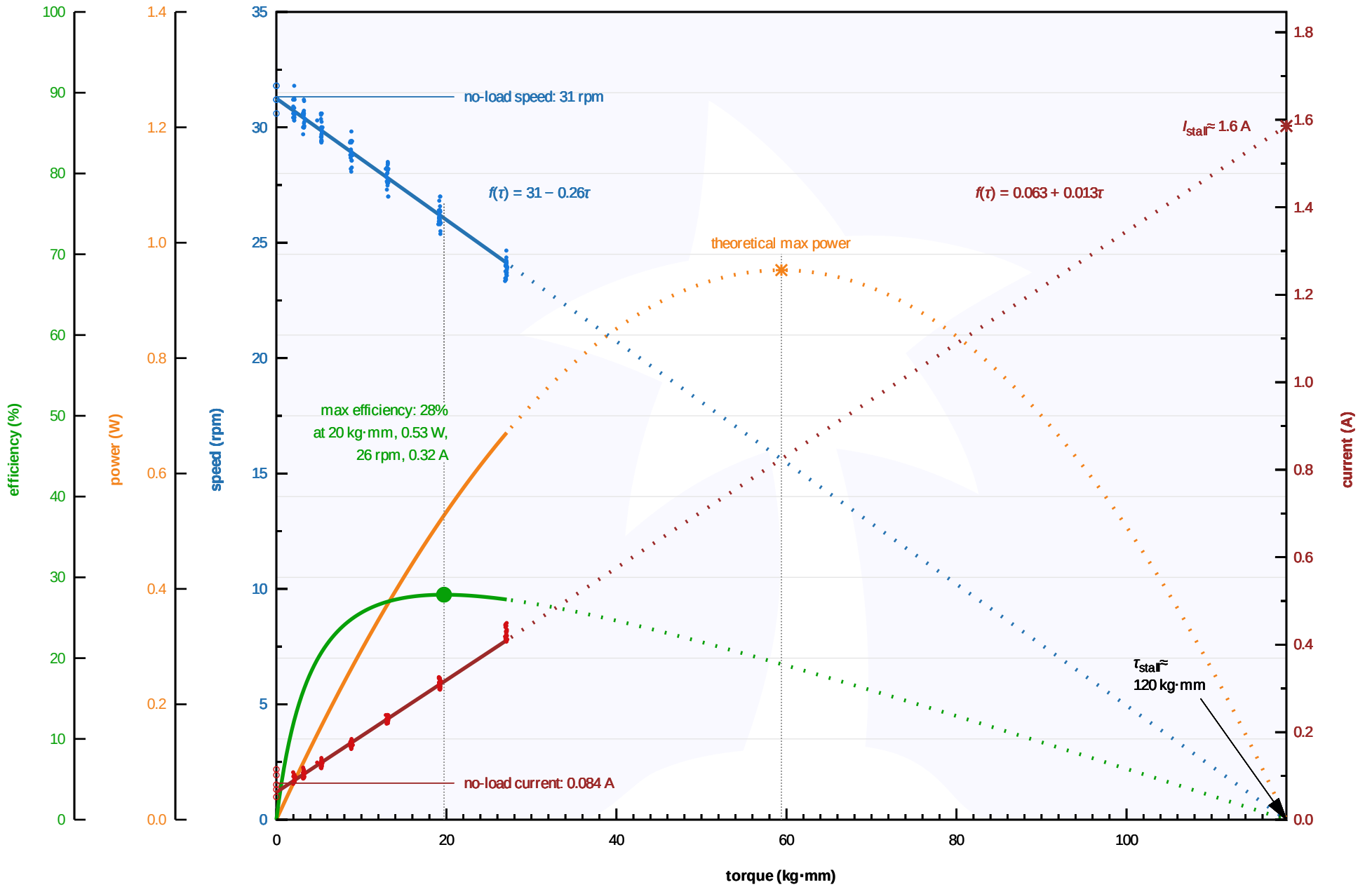

Pololu Items #3061, #3071 (10:1 Micro Metal Gearmotor HPCB 6V) Performance at 6 V

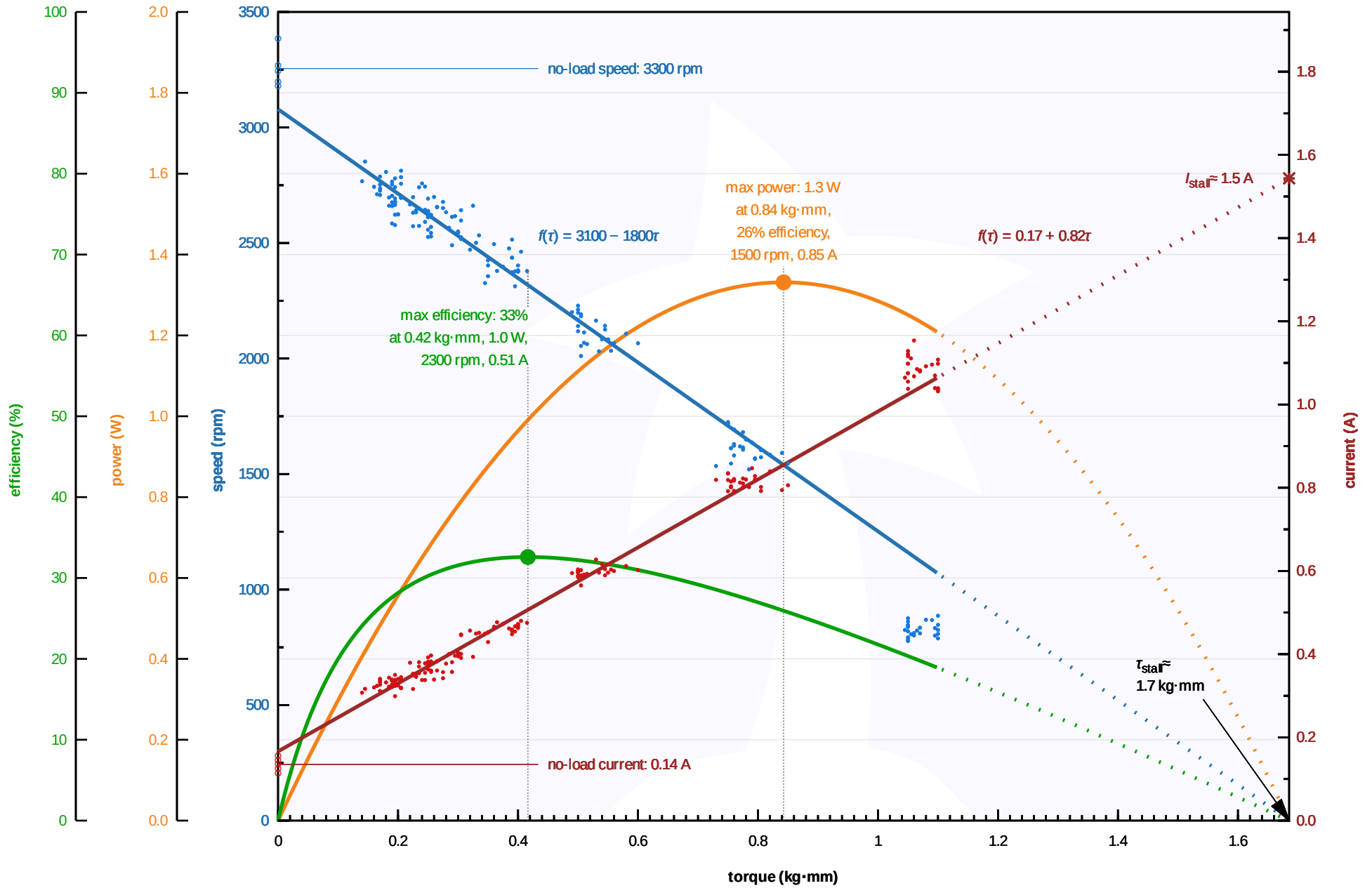

Pololu Items #4786, #4787 (15:1 Micro Metal Gearmotor HPCB 6V) Performance at 6 V

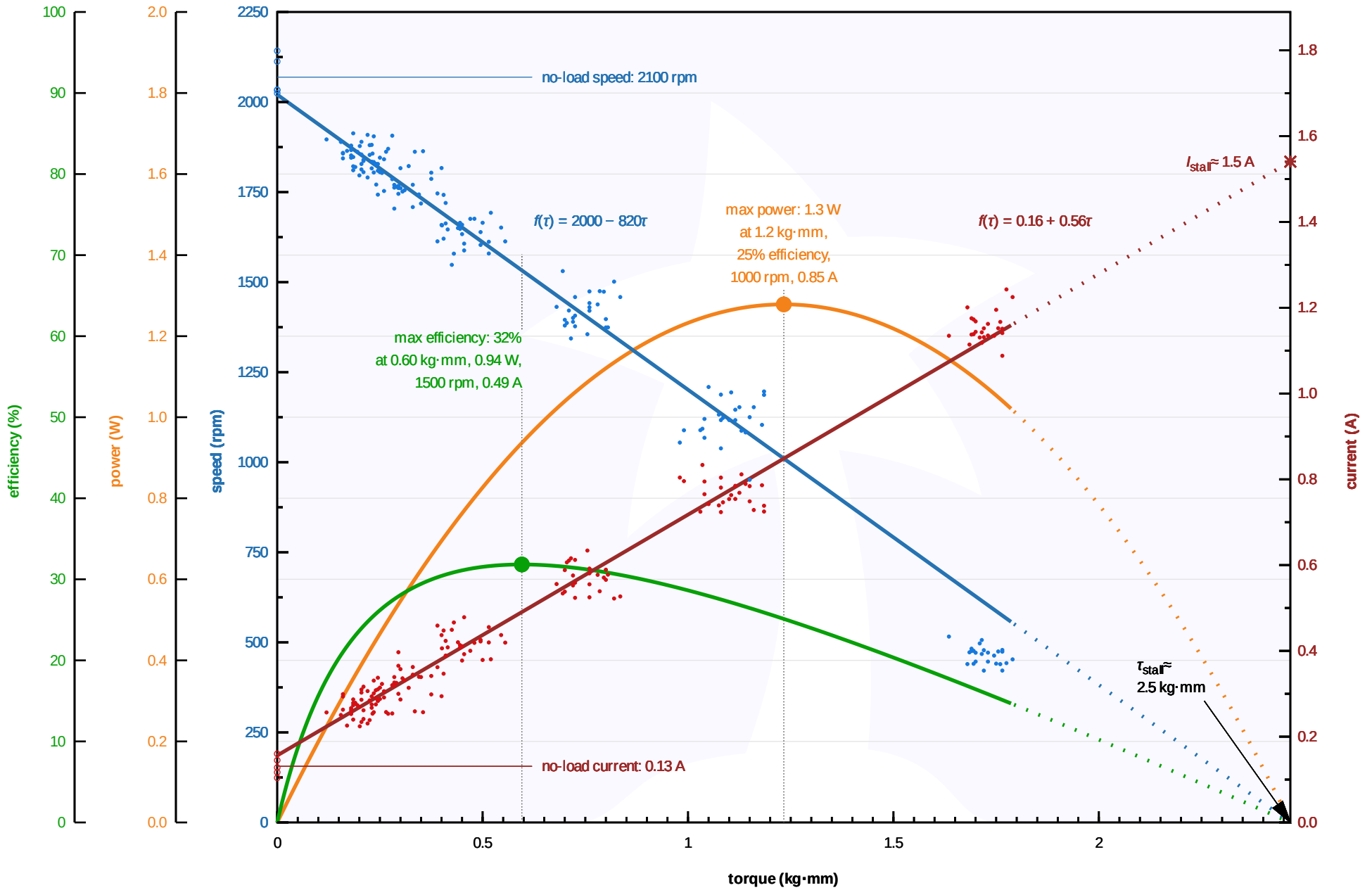

Pololu Items #3062, #3072 (30:1 Micro Metal Gearmotor HPCB 6V) Performance at 6 V

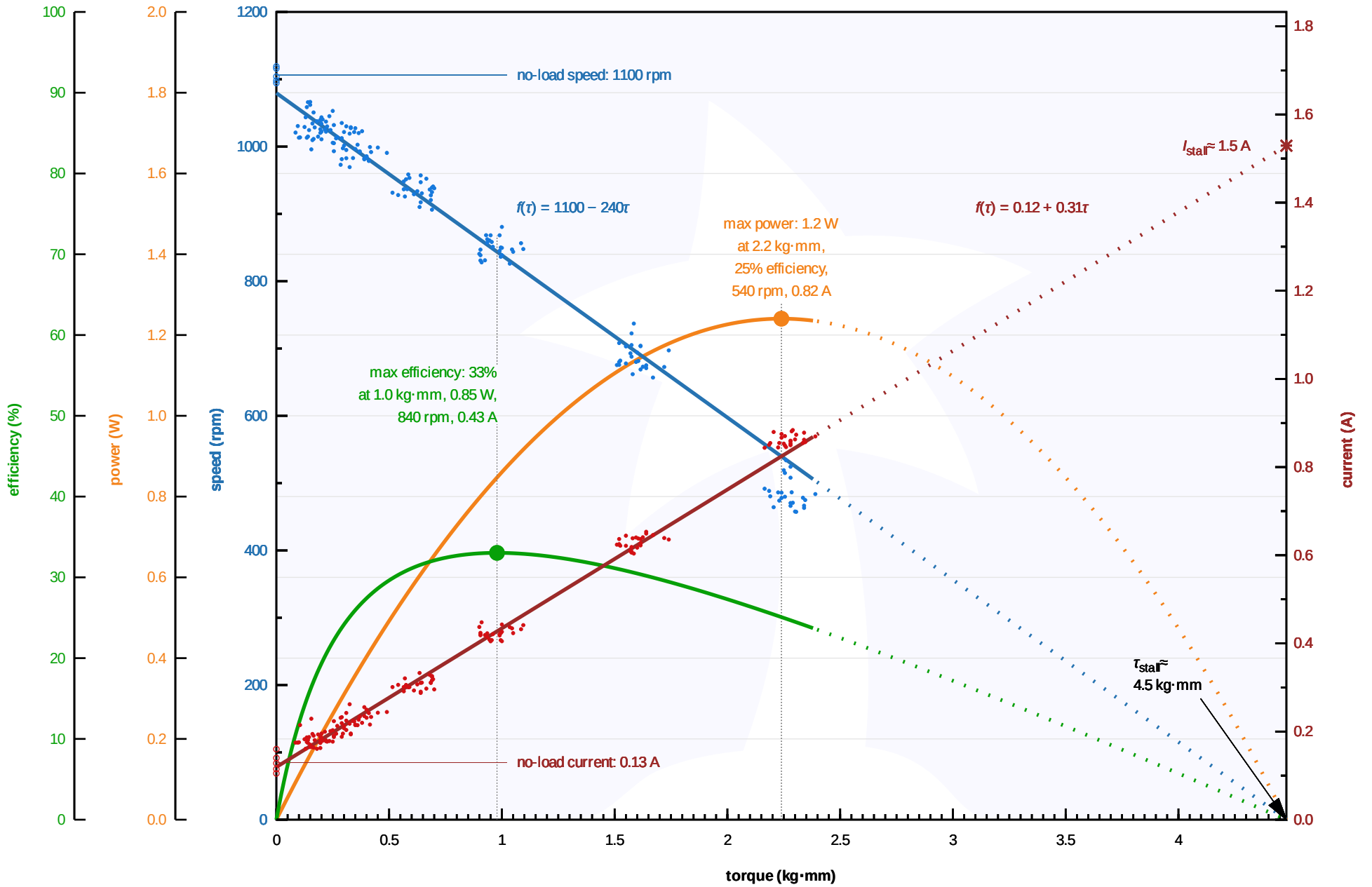

Pololu Items #3063, #3073 (50:1 Micro Metal Gearmotor HPCB 6V) Performance at 6 V

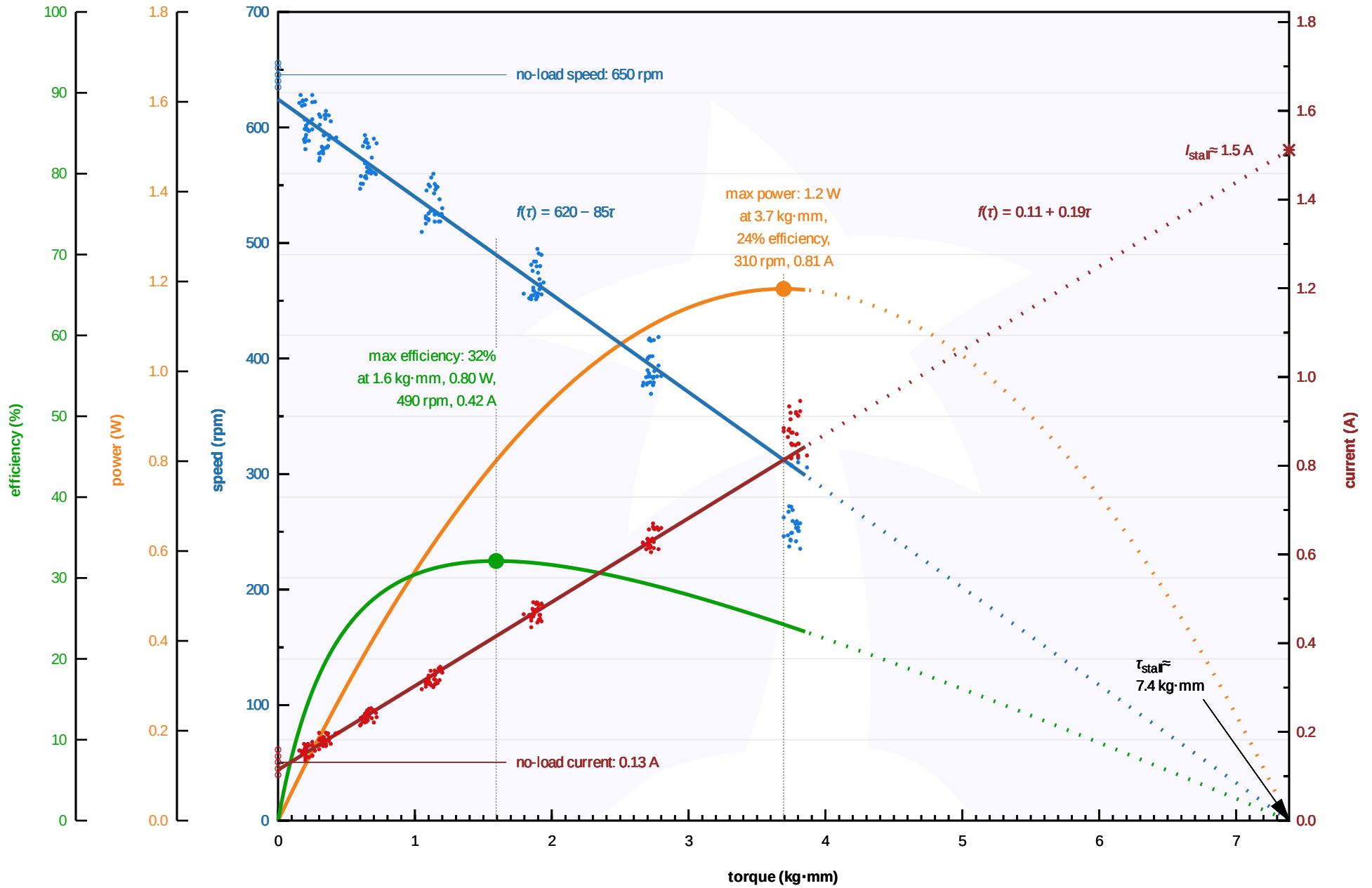

Pololu Items #3064, #3074 (75:1 Micro Metal Gearmotor HPCB 6V) Performance at 6 V

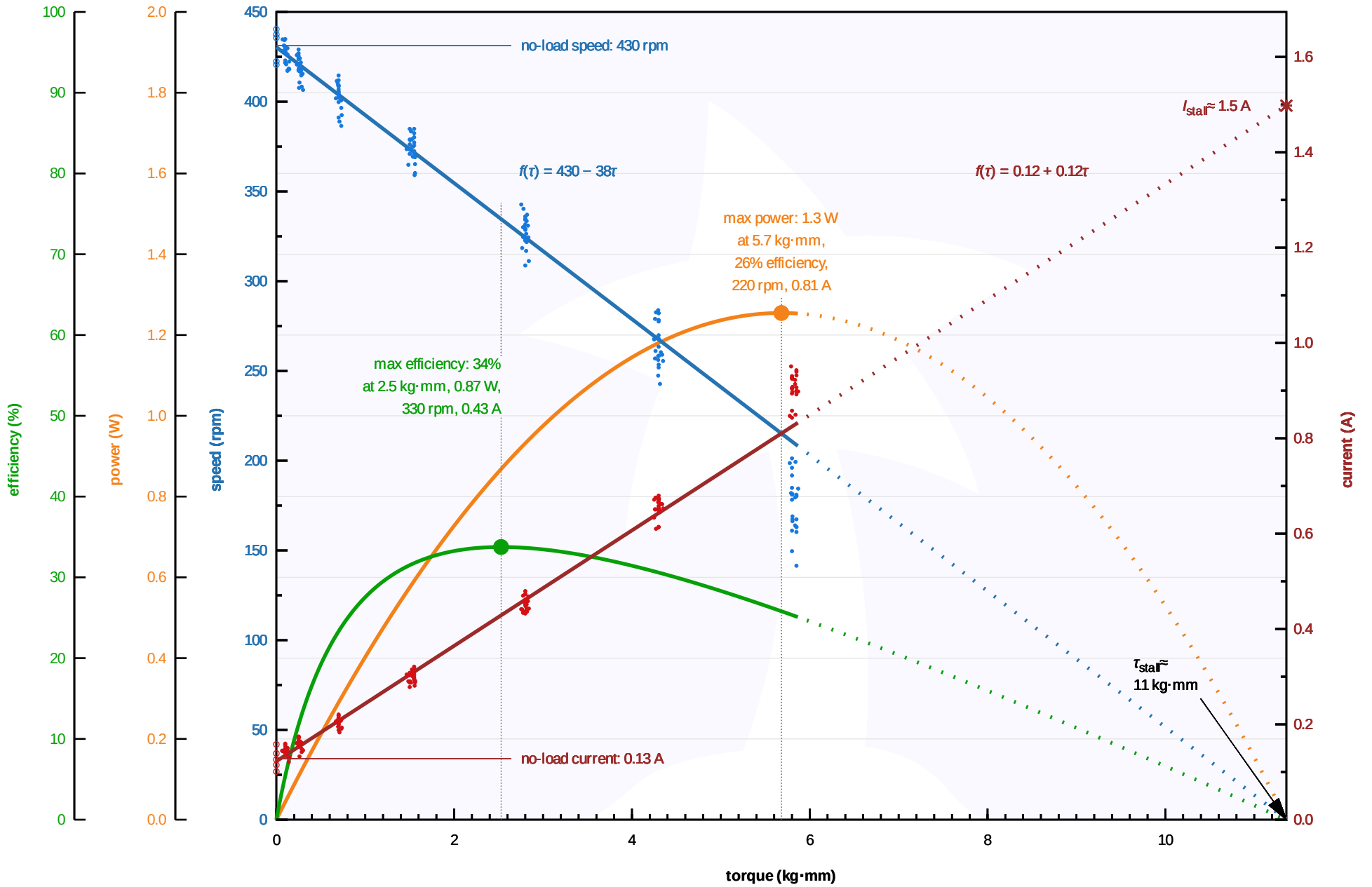

Pololu Items #3065, #3075 (100:1 Micro Metal Gearmotor HPCB 6V) Performance at 6 V

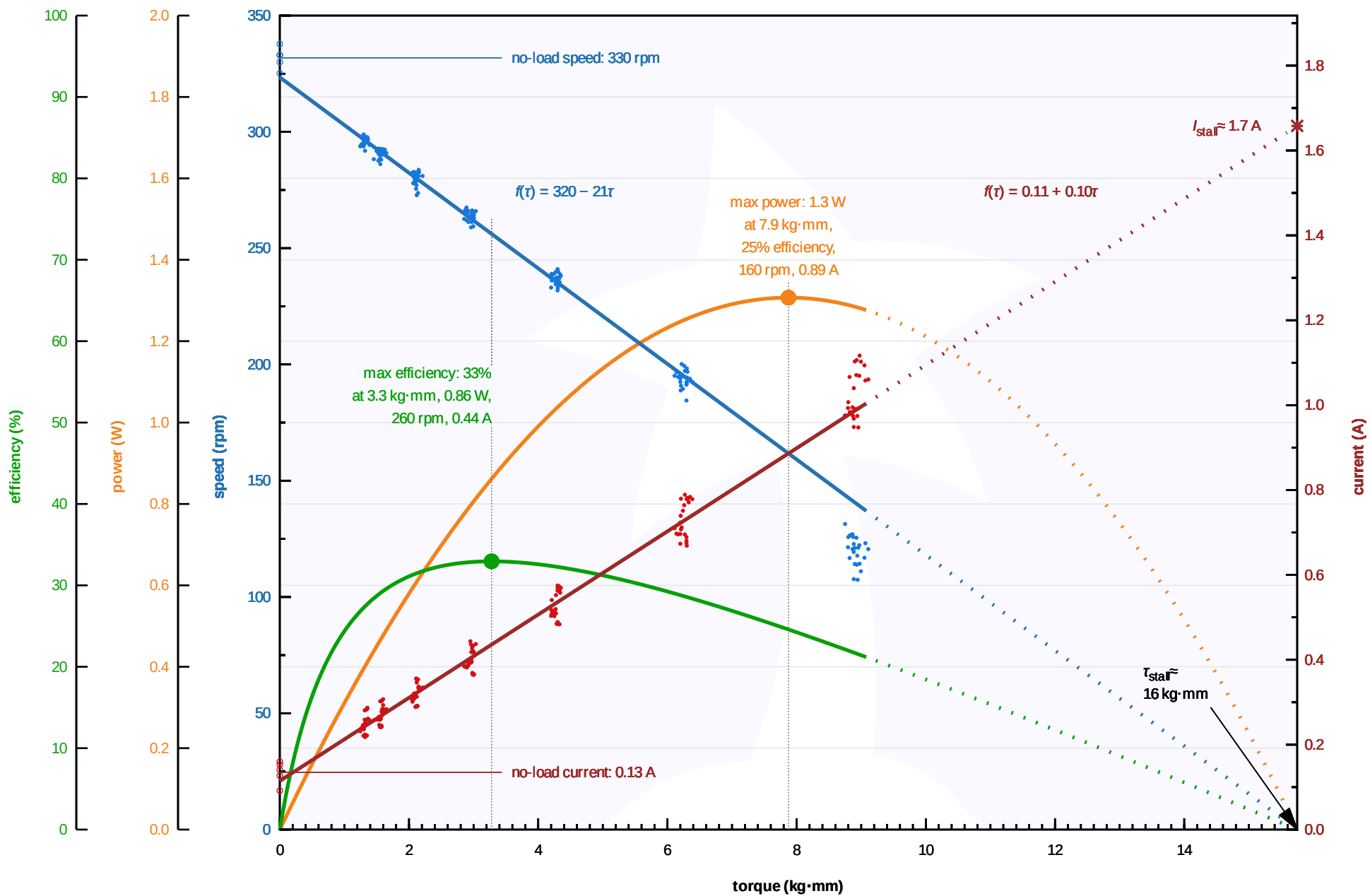

Pololu Items #3066, #3076 (150:1 Micro Metal Gearmotor HPCB 6V) Performance at 6 V

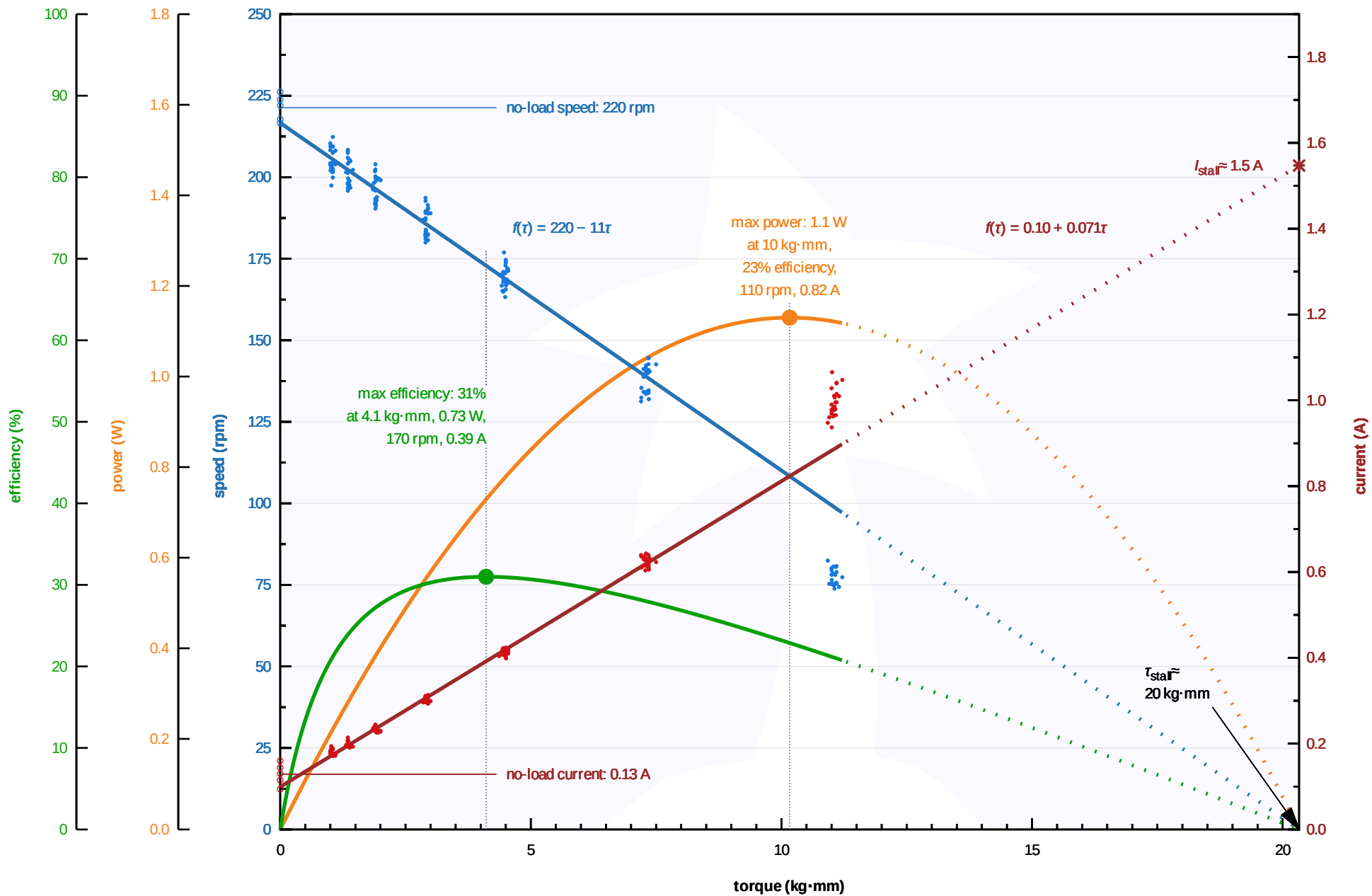

Pololu Items #3067, #3077 (210:1 Micro Metal Gearmotor HPCB 6V) Performance at 6 V

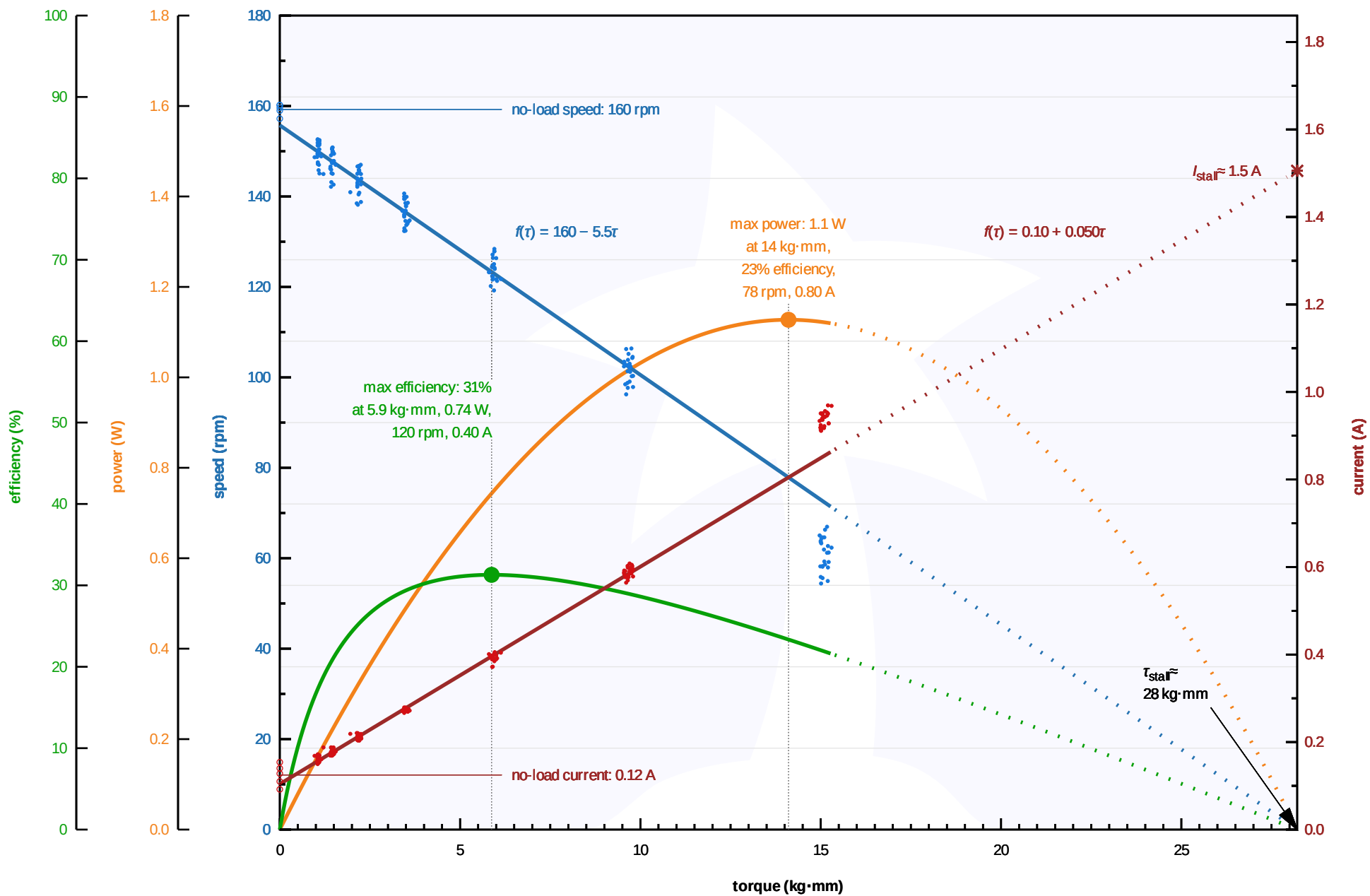

Pololu Items #3068, #3078 (250:1 Micro Metal Gearmotor HPCB 6V) Performance at 6 V

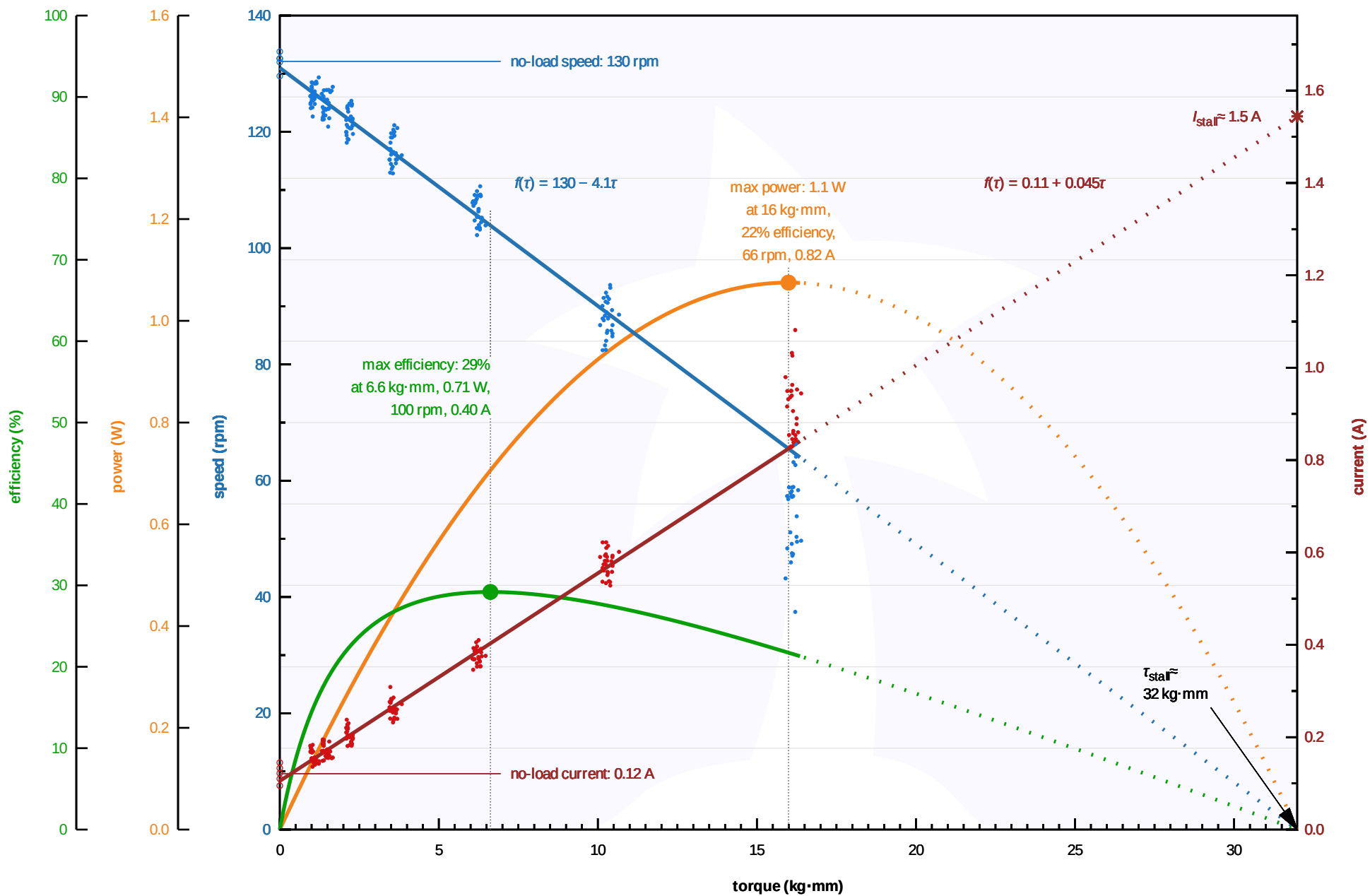

Pololu Items #3069, #3079 (298:1 Micro Metal Gearmotor HPCB 6V) Performance at 6 V

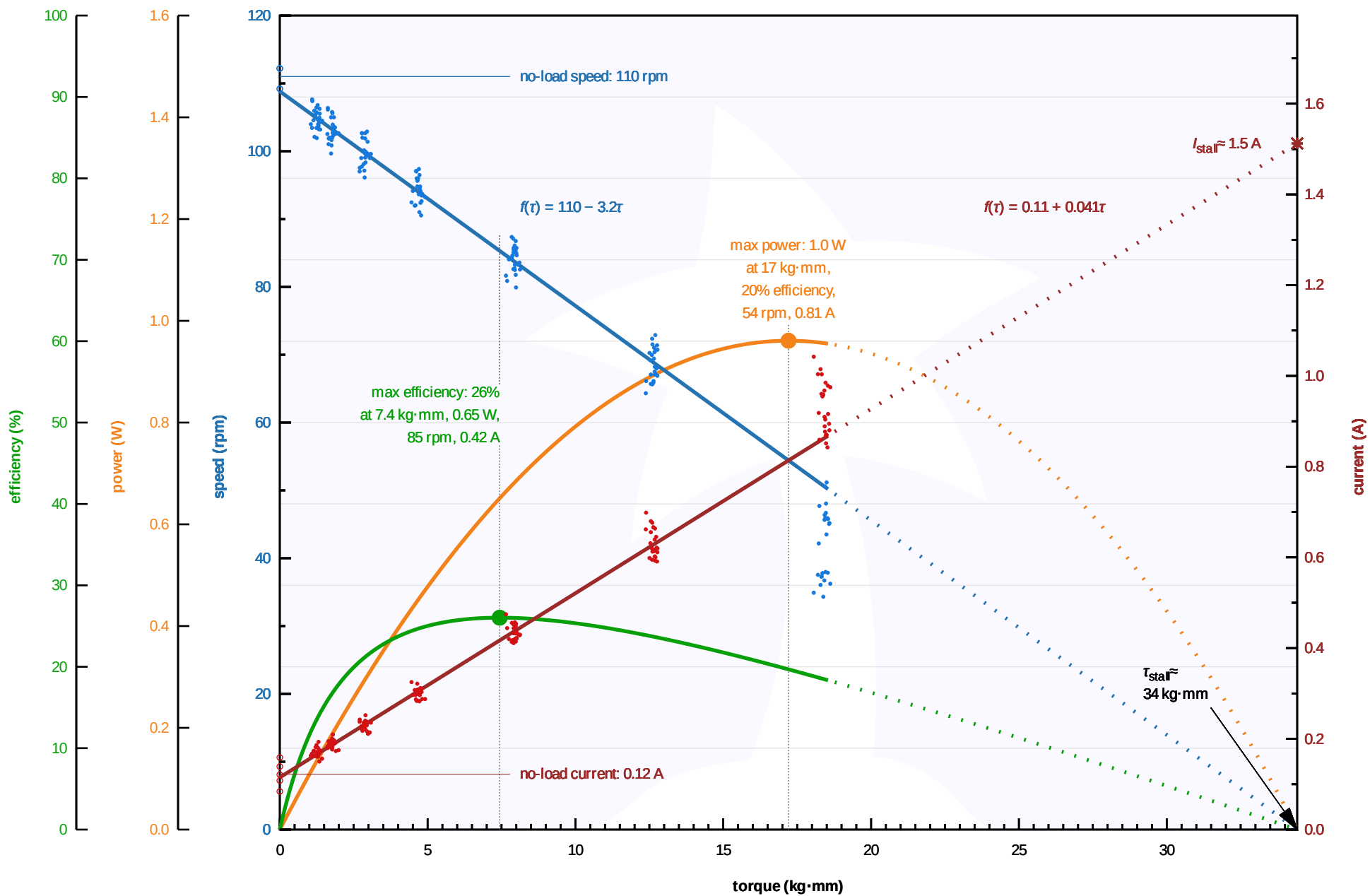

Pololu Items #4796, #4797 (380:1 Micro Metal Gearmotor HPCB 6V) Performance at 6 V

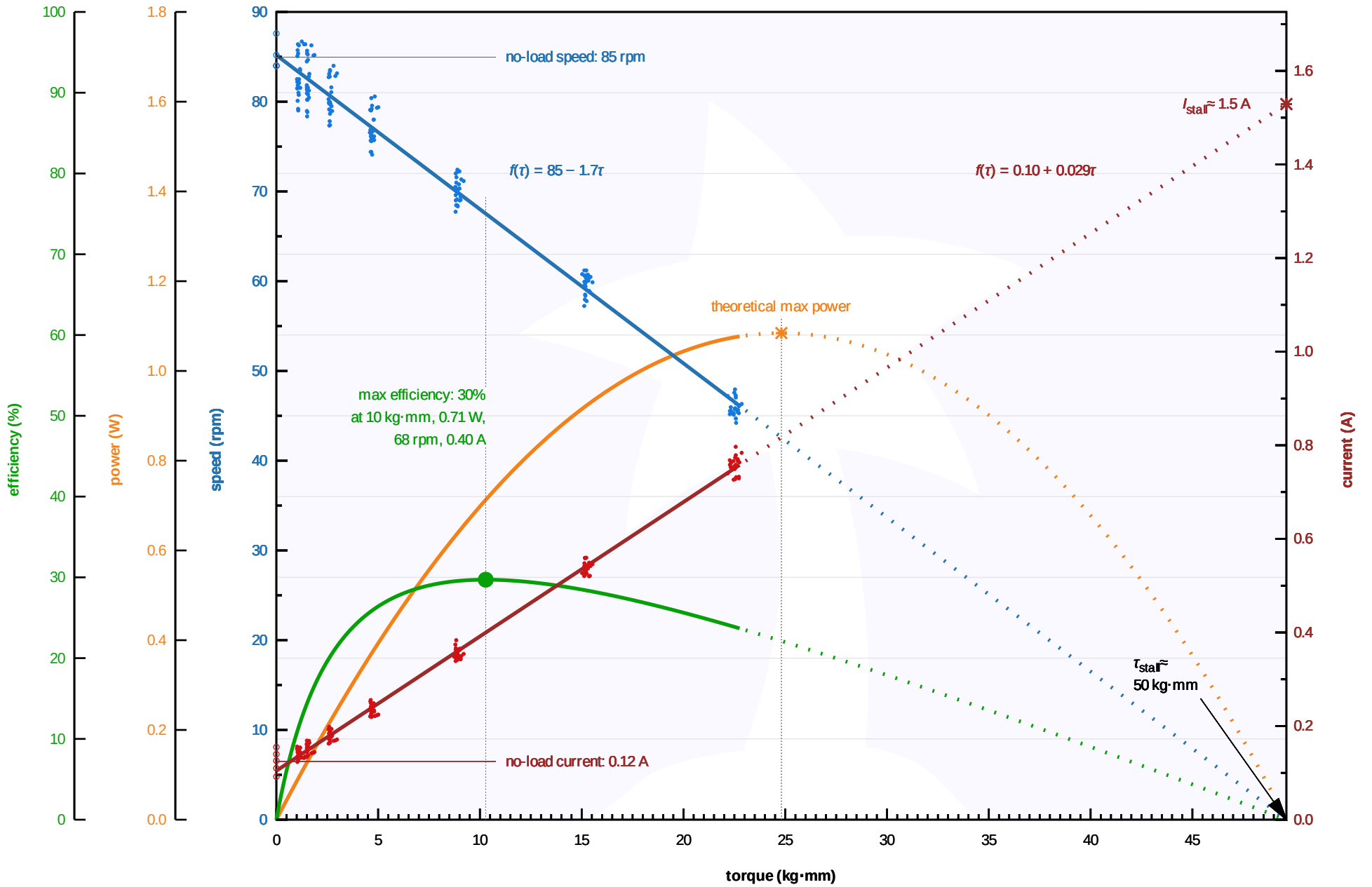

Pololu Items #3070, #3080 (1000:1 Micro Metal Gearmotor HPCB 6V) Performance at 6 V

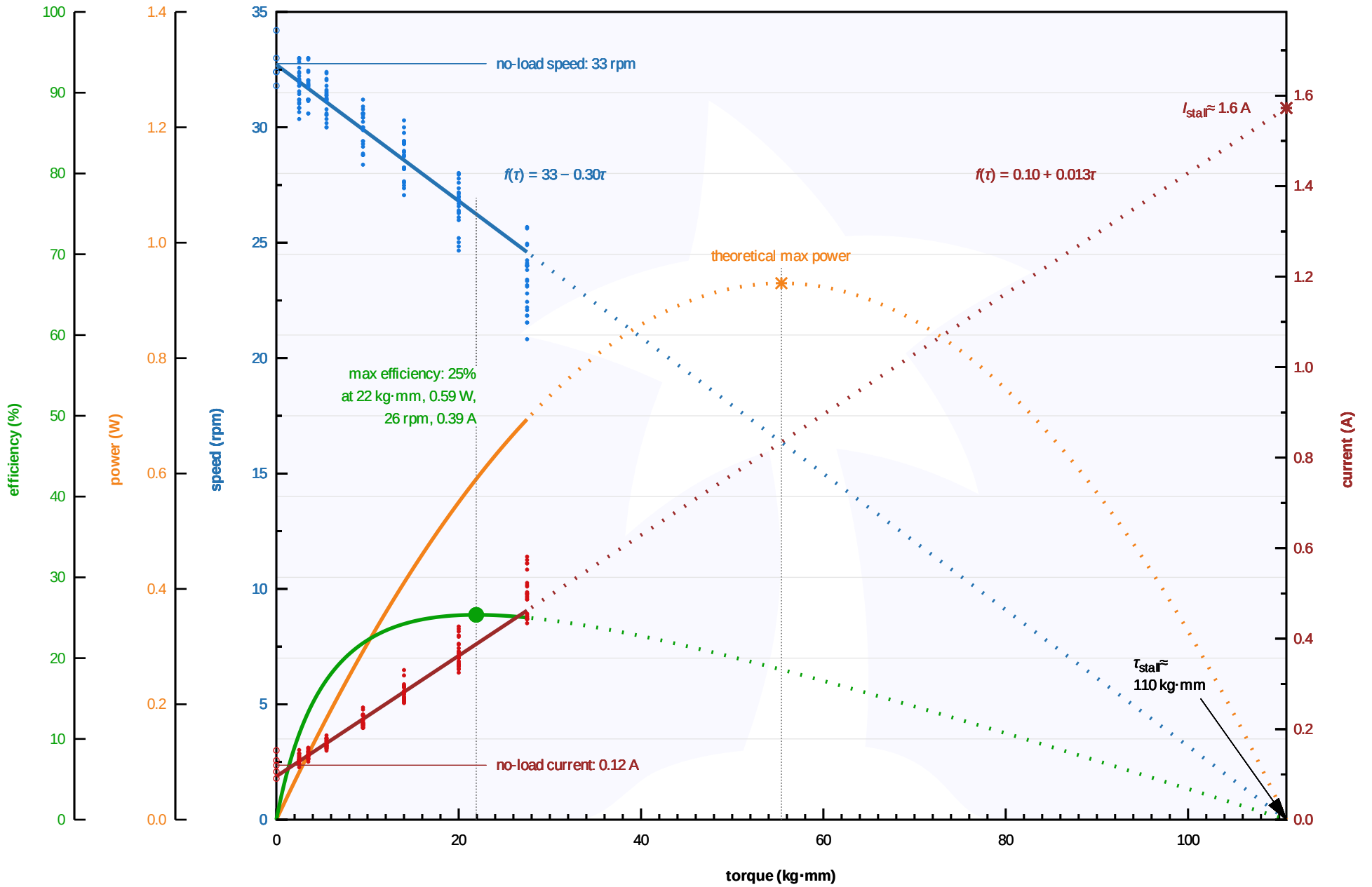

Pololu Items #3037, #3048 (10:1 Micro Metal Gearmotor HPCB 12V) Performance at 12 V

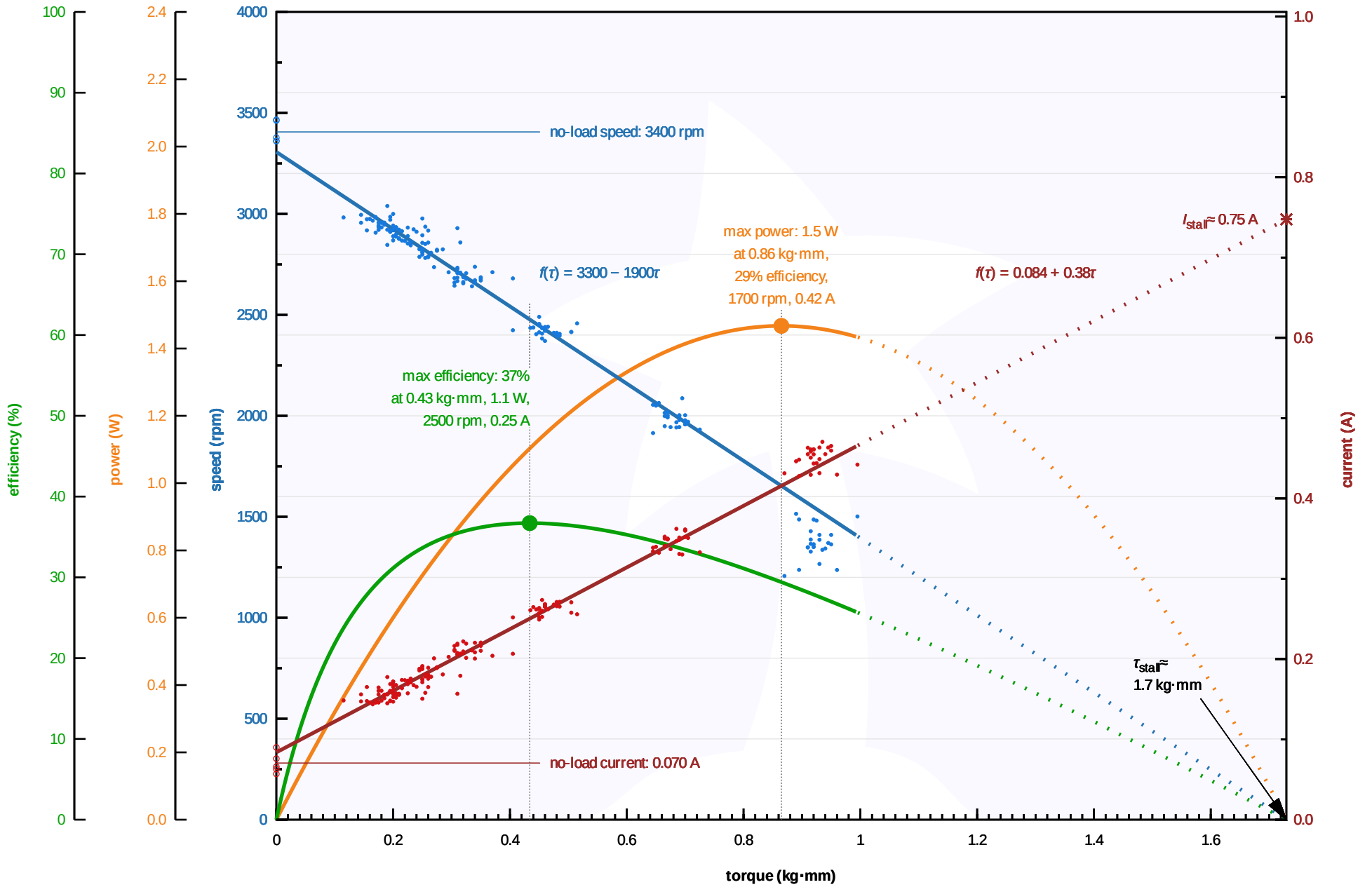

Pololu Items #4788, #4789 (15:1 Micro Metal Gearmotor HPCB 12V) Performance at 12 V

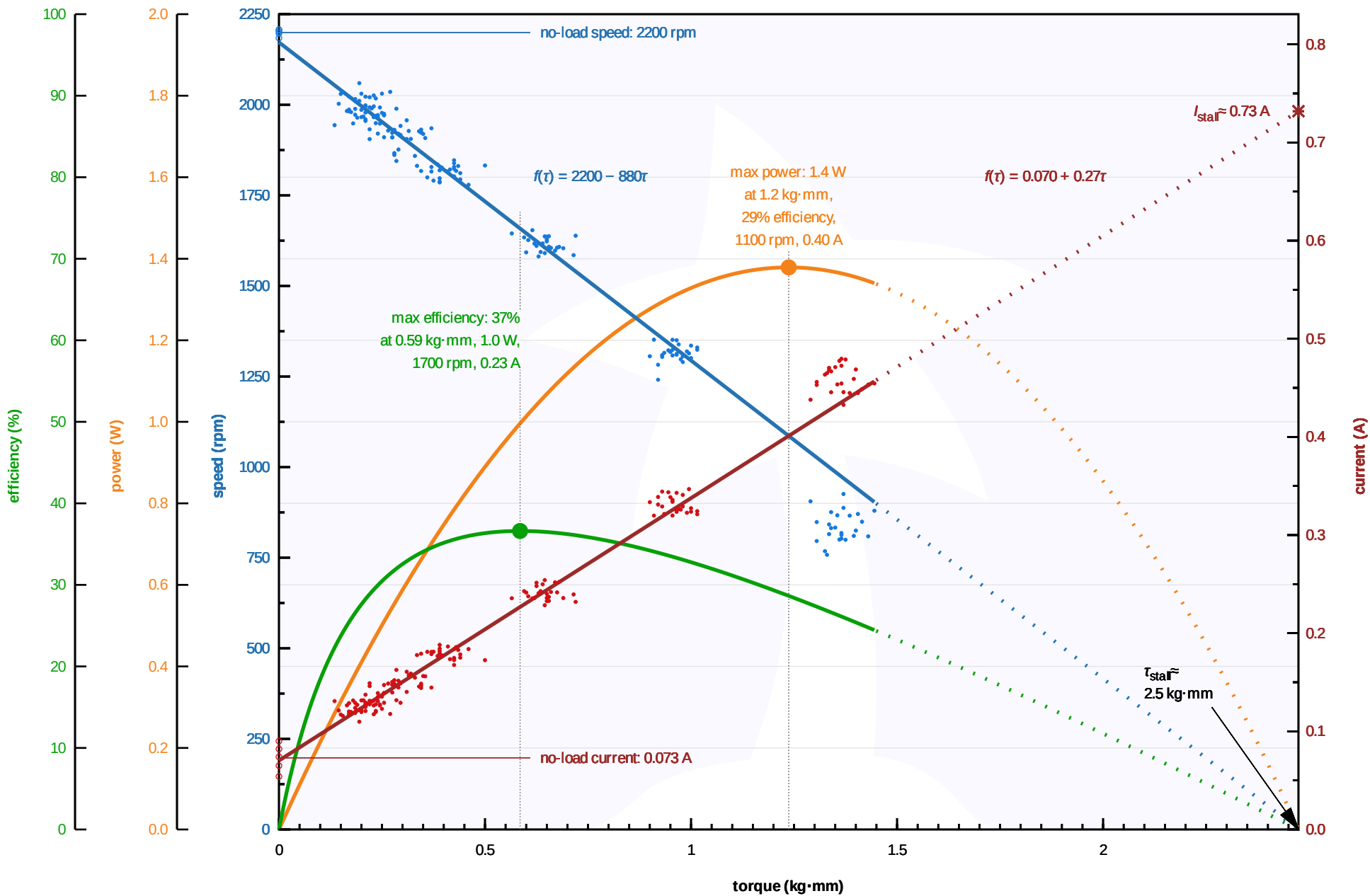

Pololu Items #3038, #3049 (30:1 Micro Metal Gearmotor HPCB 12V) Performance at 12 V

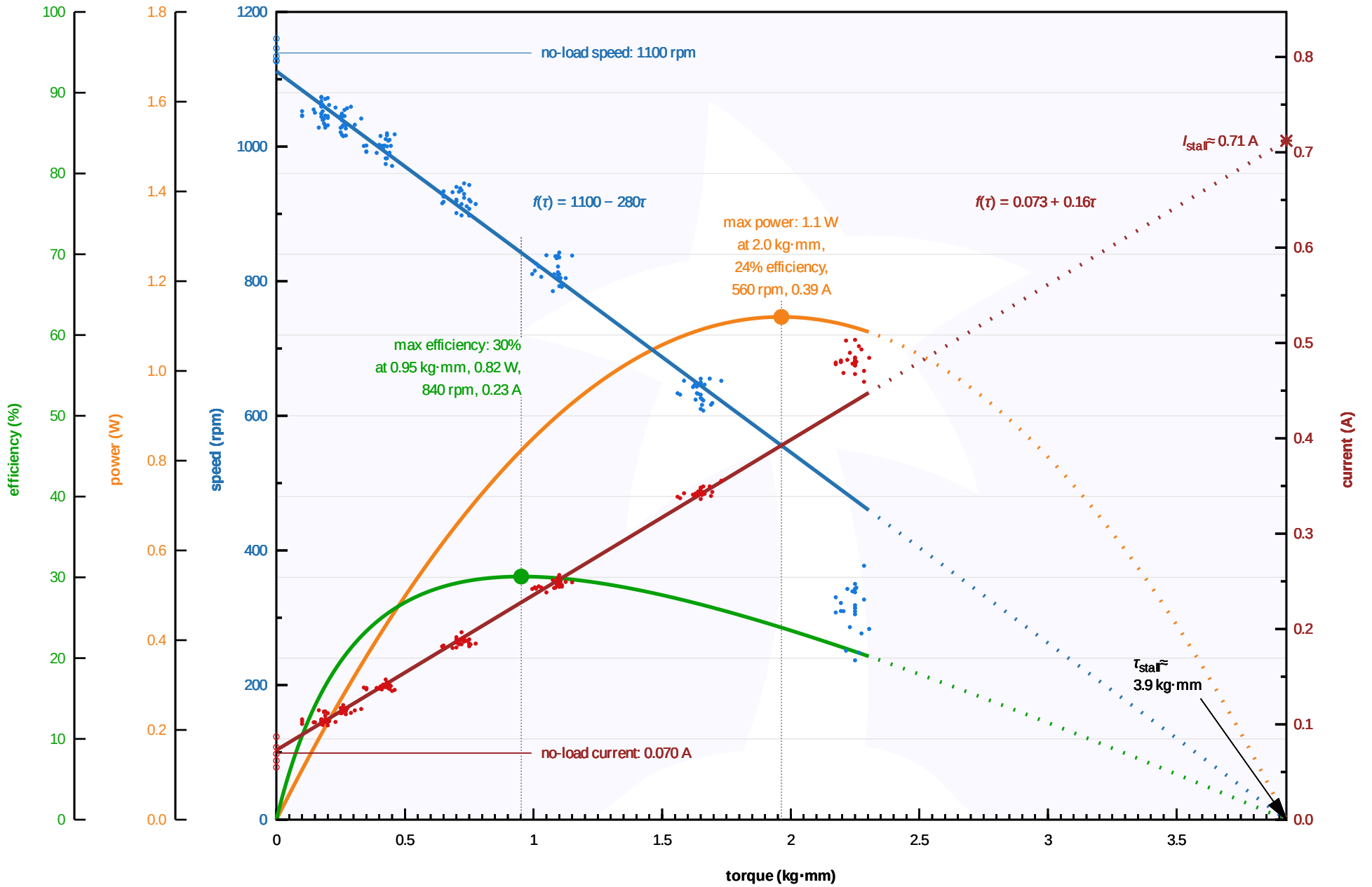

Pololu Items #3039, #3050 (50:1 Micro Metal Gearmotor HPCB 12V) Performance at 12 V

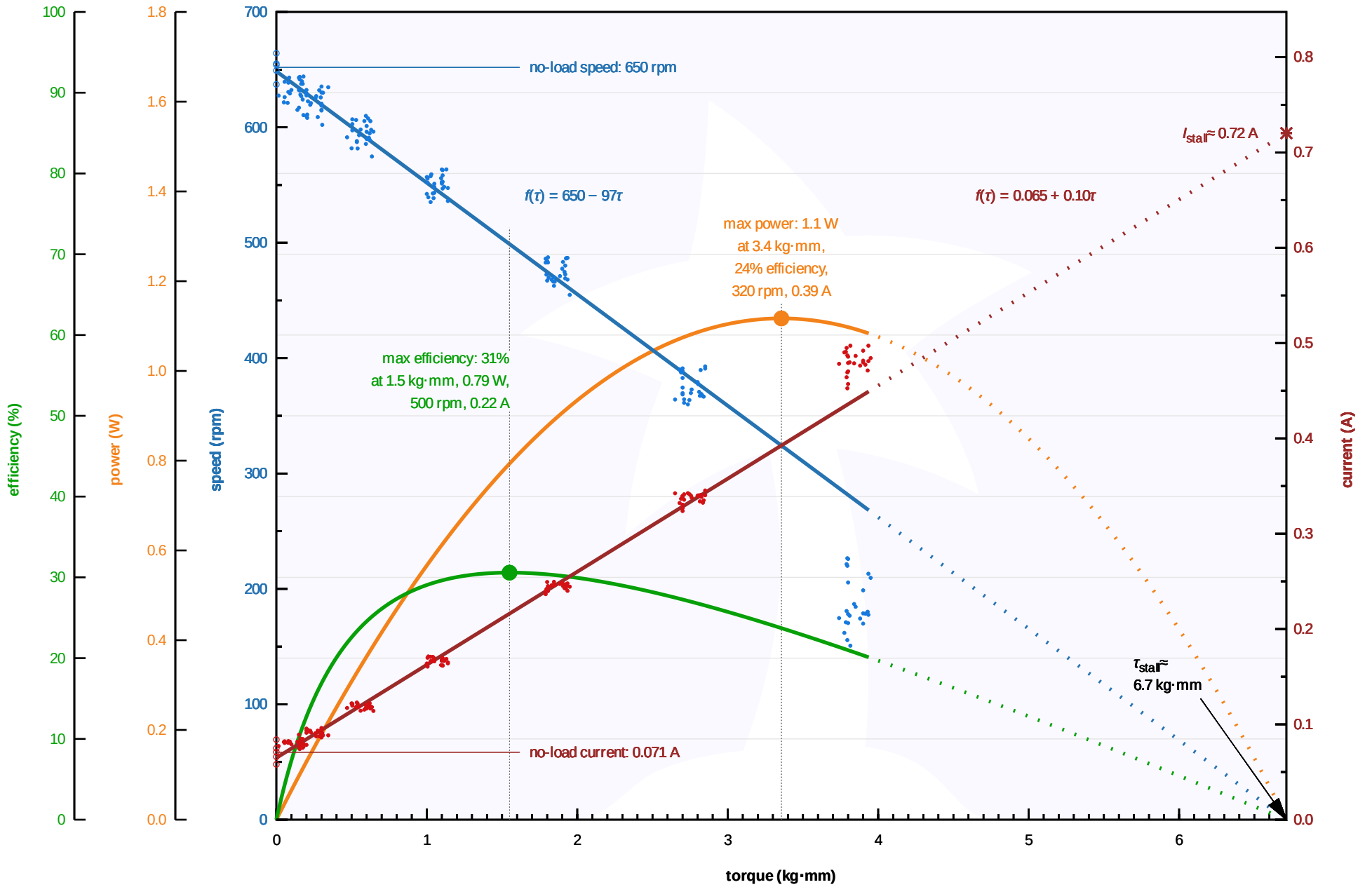

Pololu Items #3040, #3051 (75:1 Micro Metal Gearmotor HPCB 12V) Performance at 12 V

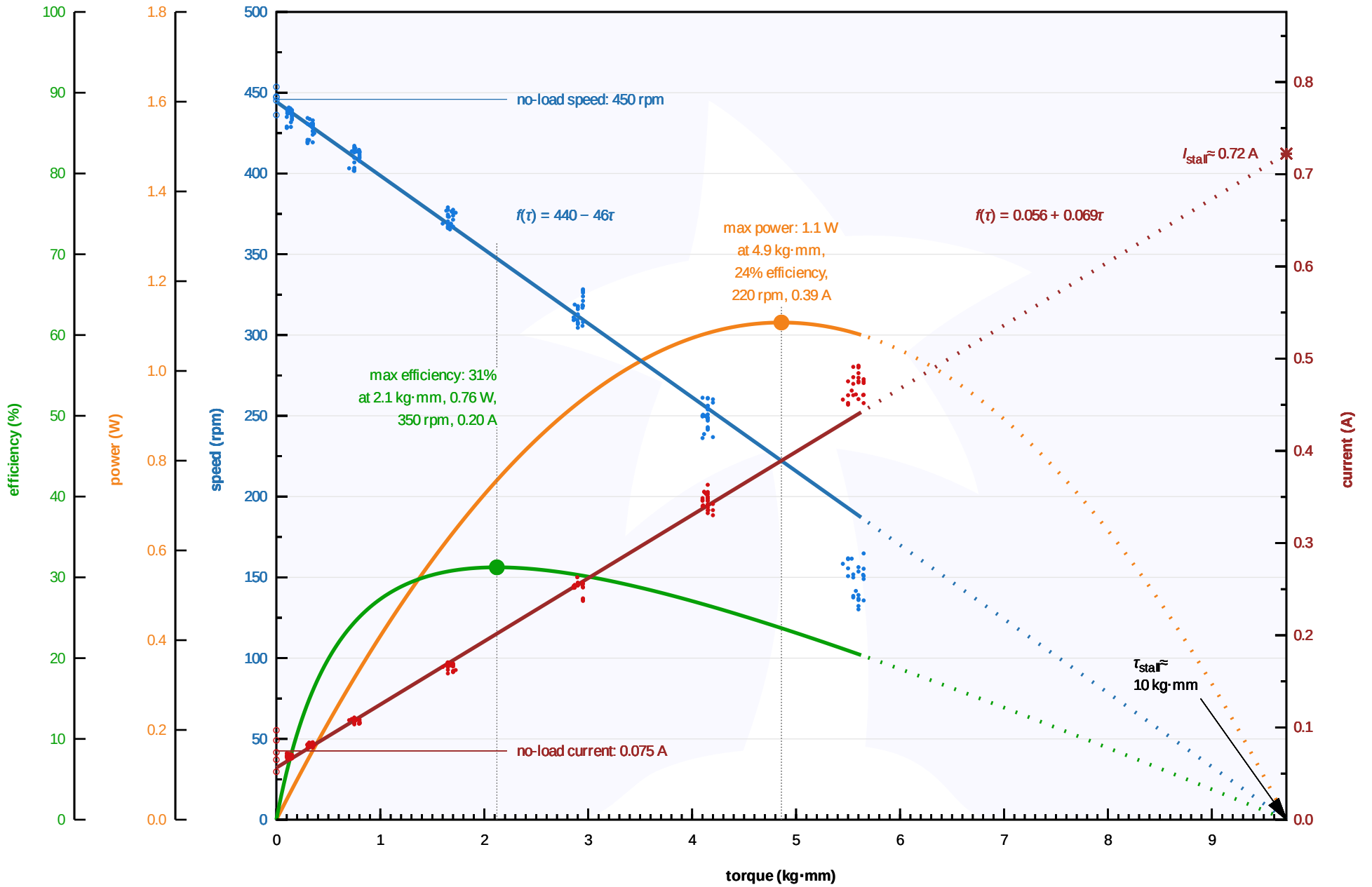

Pololu Items #3041, #3052 (100:1 Micro Metal Gearmotor HPCB 12V) Performance at 12 V

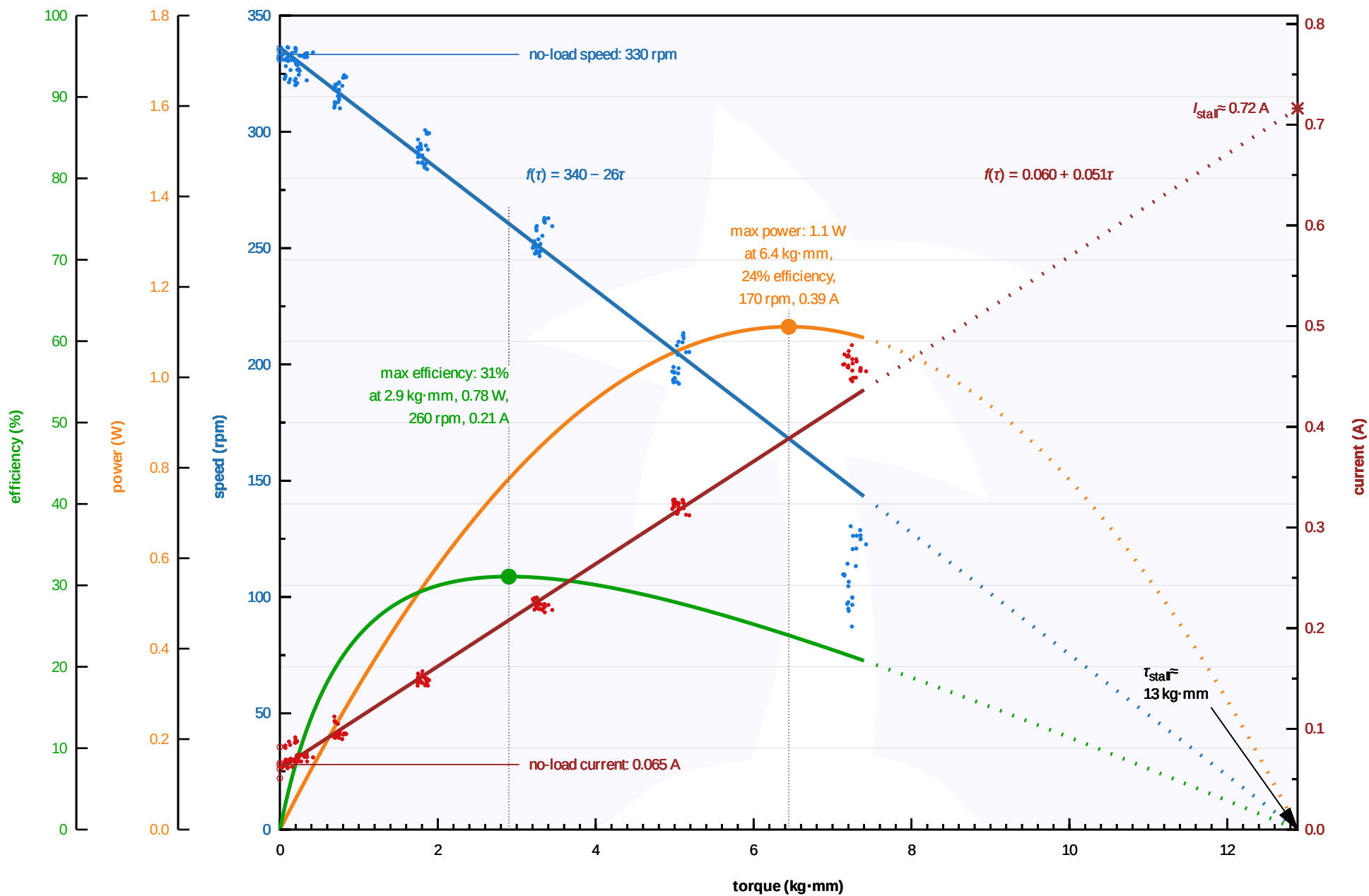

Pololu Items #3042, #3053 (150:1 Micro Metal Gearmotor HPCB 12V) Performance at 12 V

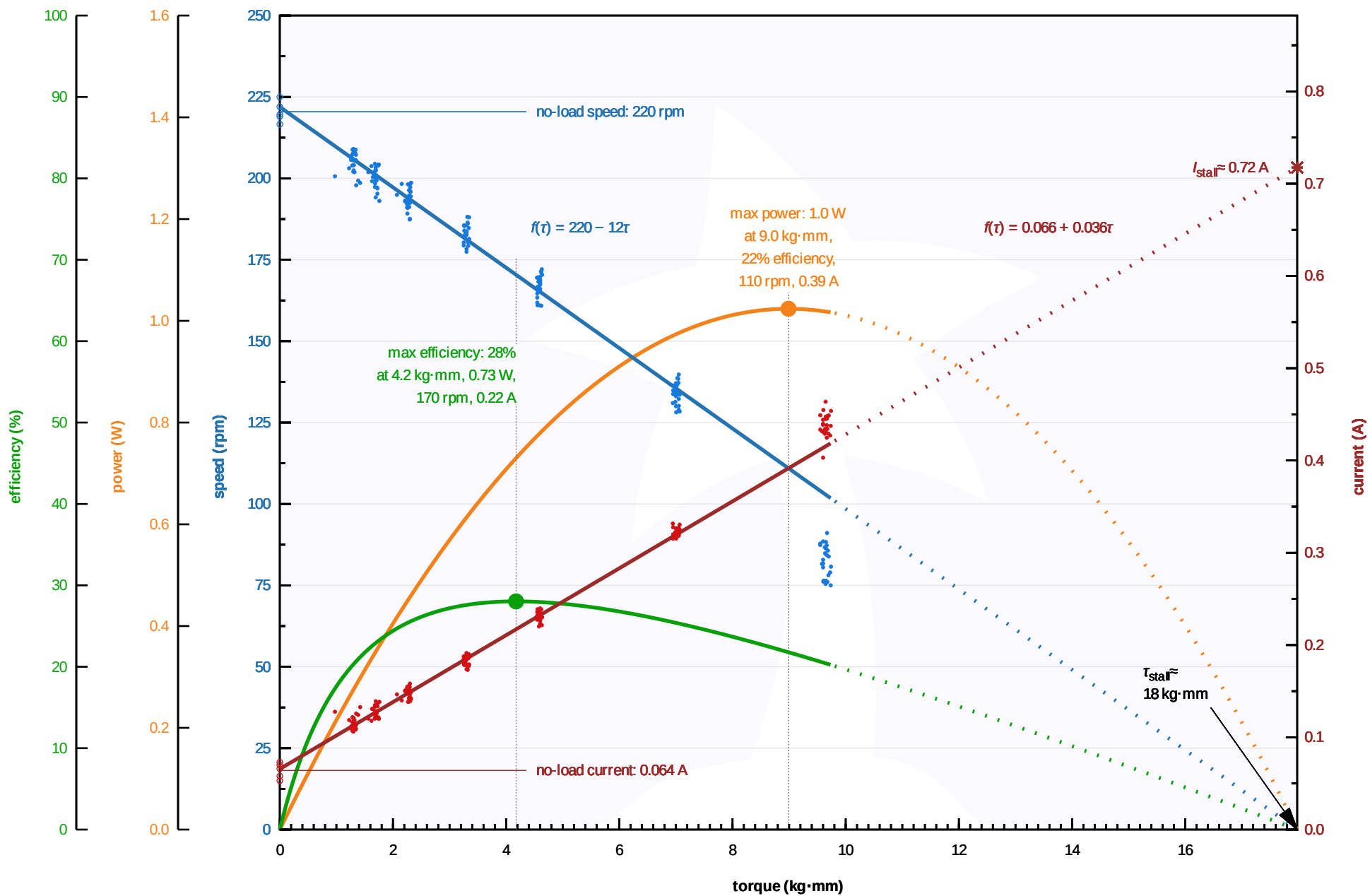

Pololu Items #3043, #3054 (210:1 Micro Metal Gearmotor HPCB 12V) Performance at 12 V

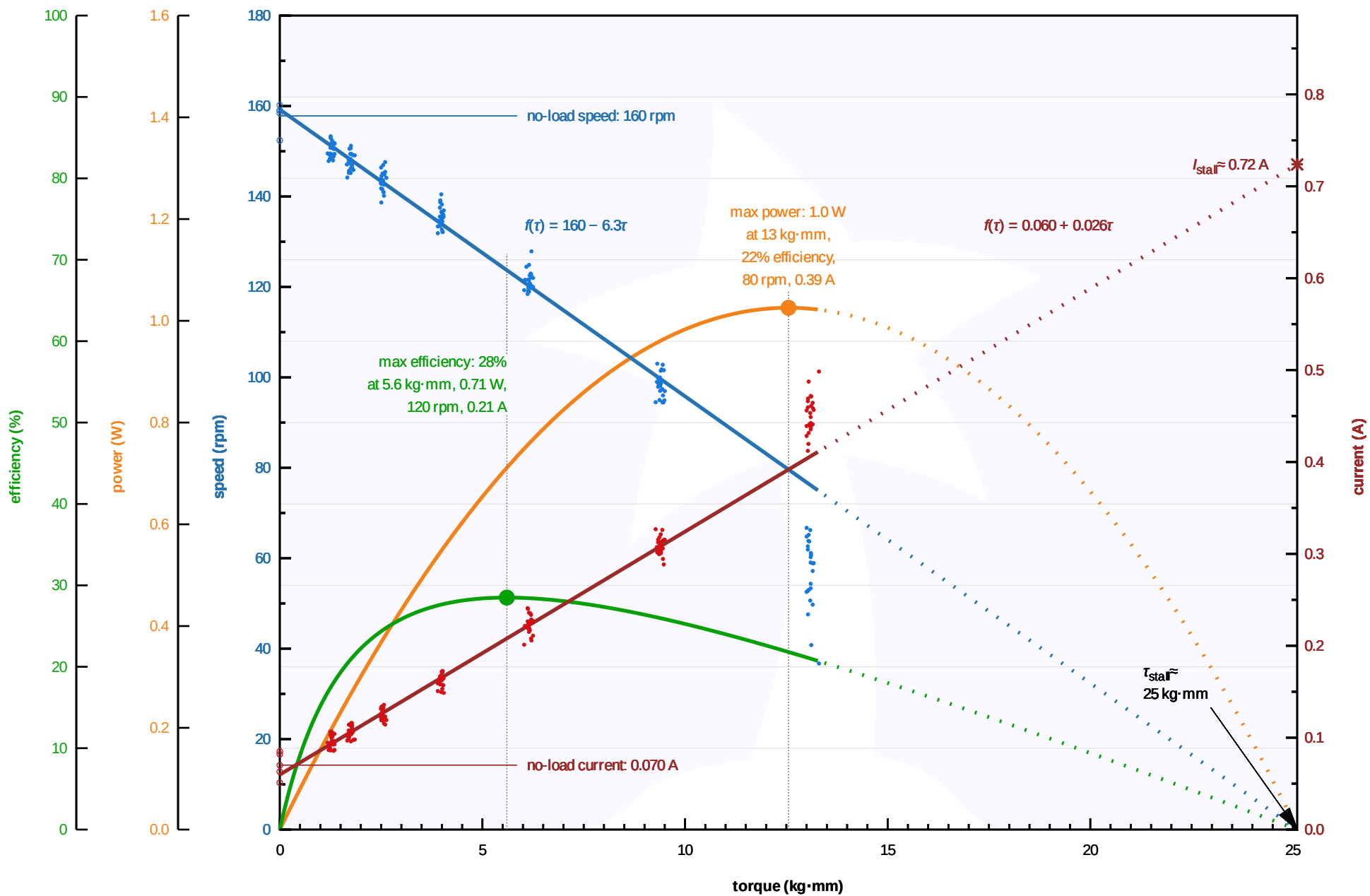

Pololu Items #3044, #3055 (250:1 Micro Metal Gearmotor HPCB 12V) Performance at 12 V

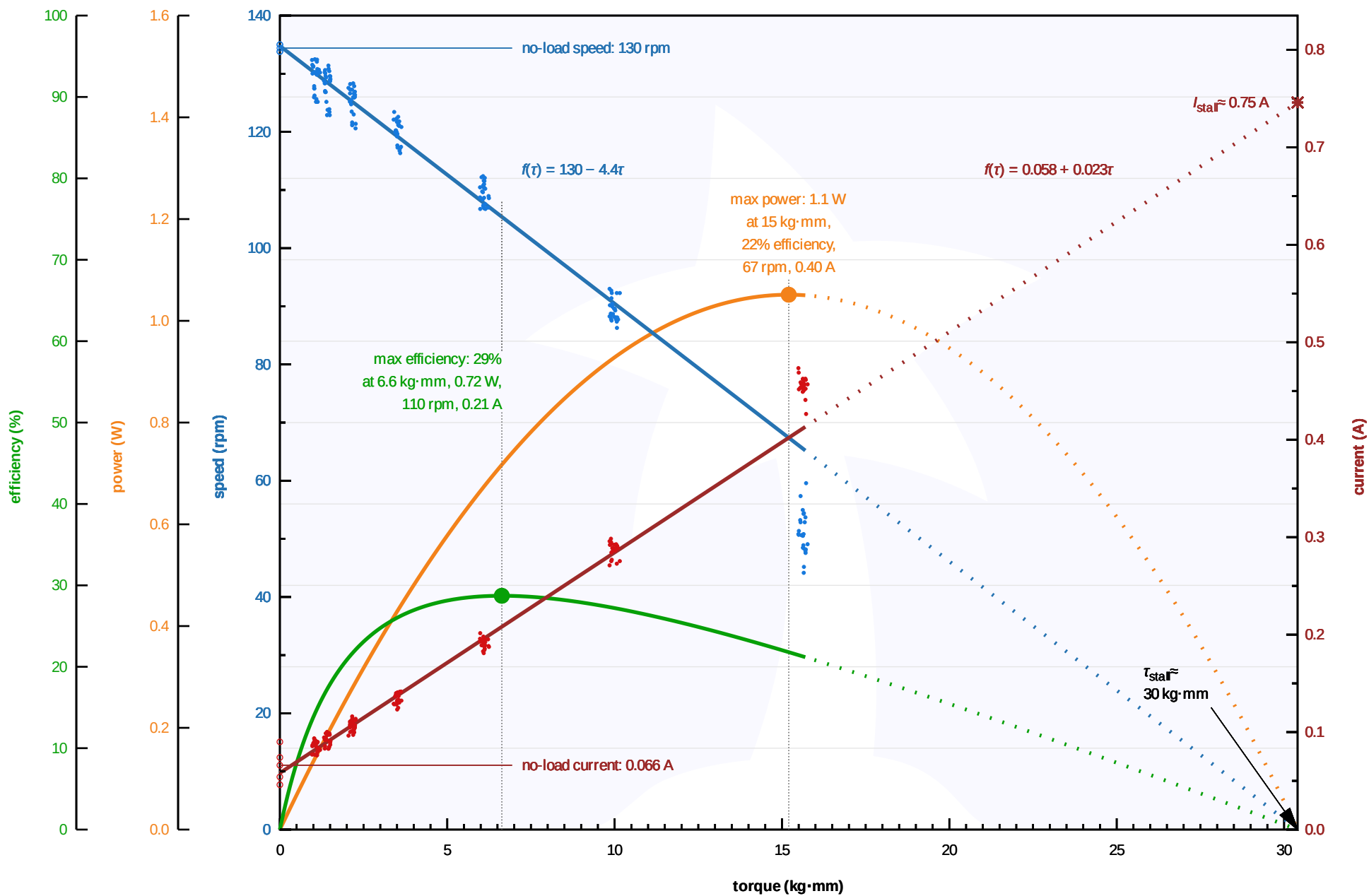

Pololu Items #3045, #3056 (298:1 Micro Metal Gearmotor HPCB 12V) Performance at 12 V

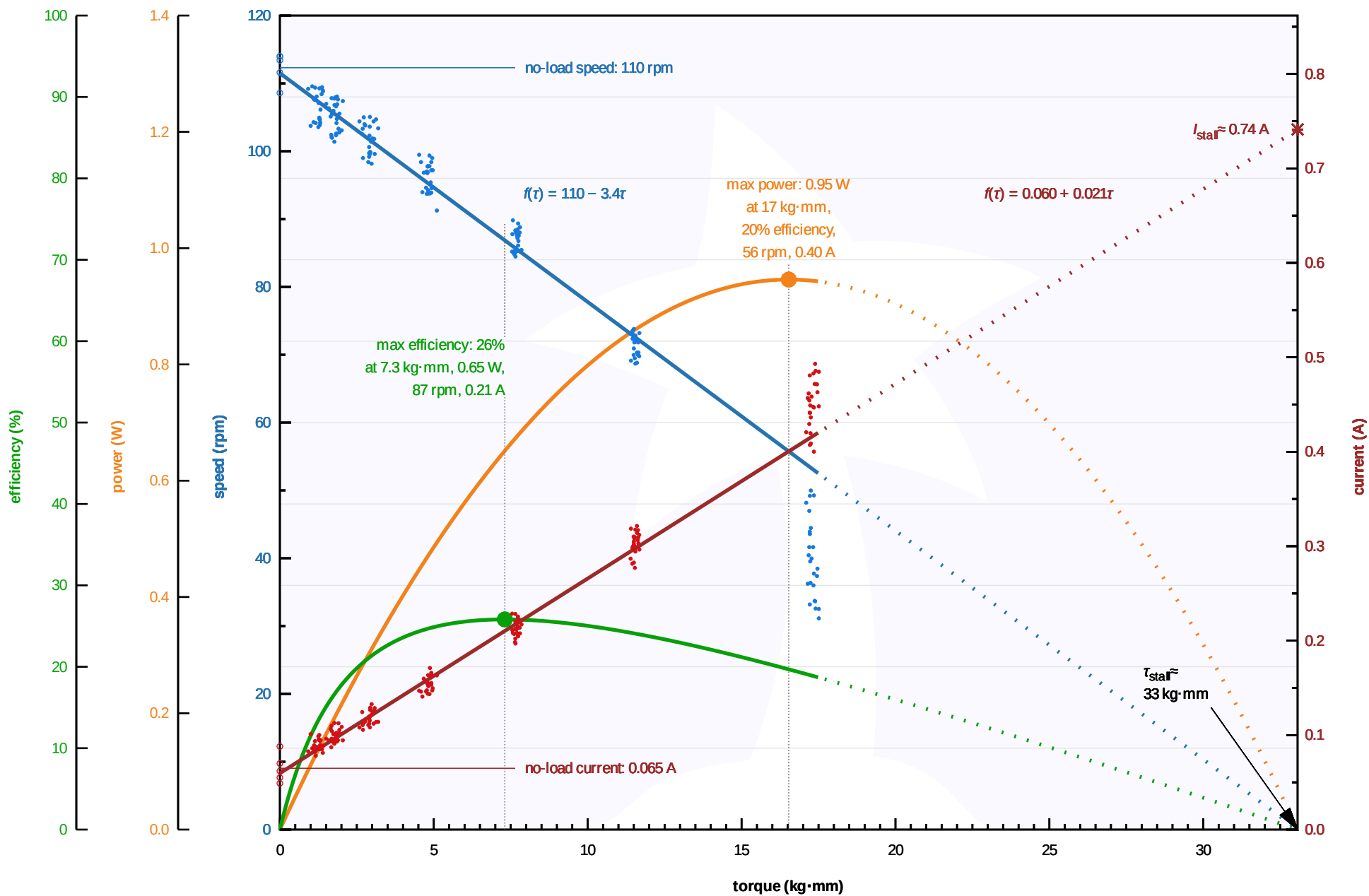

Pololu Items #4798, #4799 (380:1 Micro Metal Gearmotor HPCB 12V) Performance at 12 V

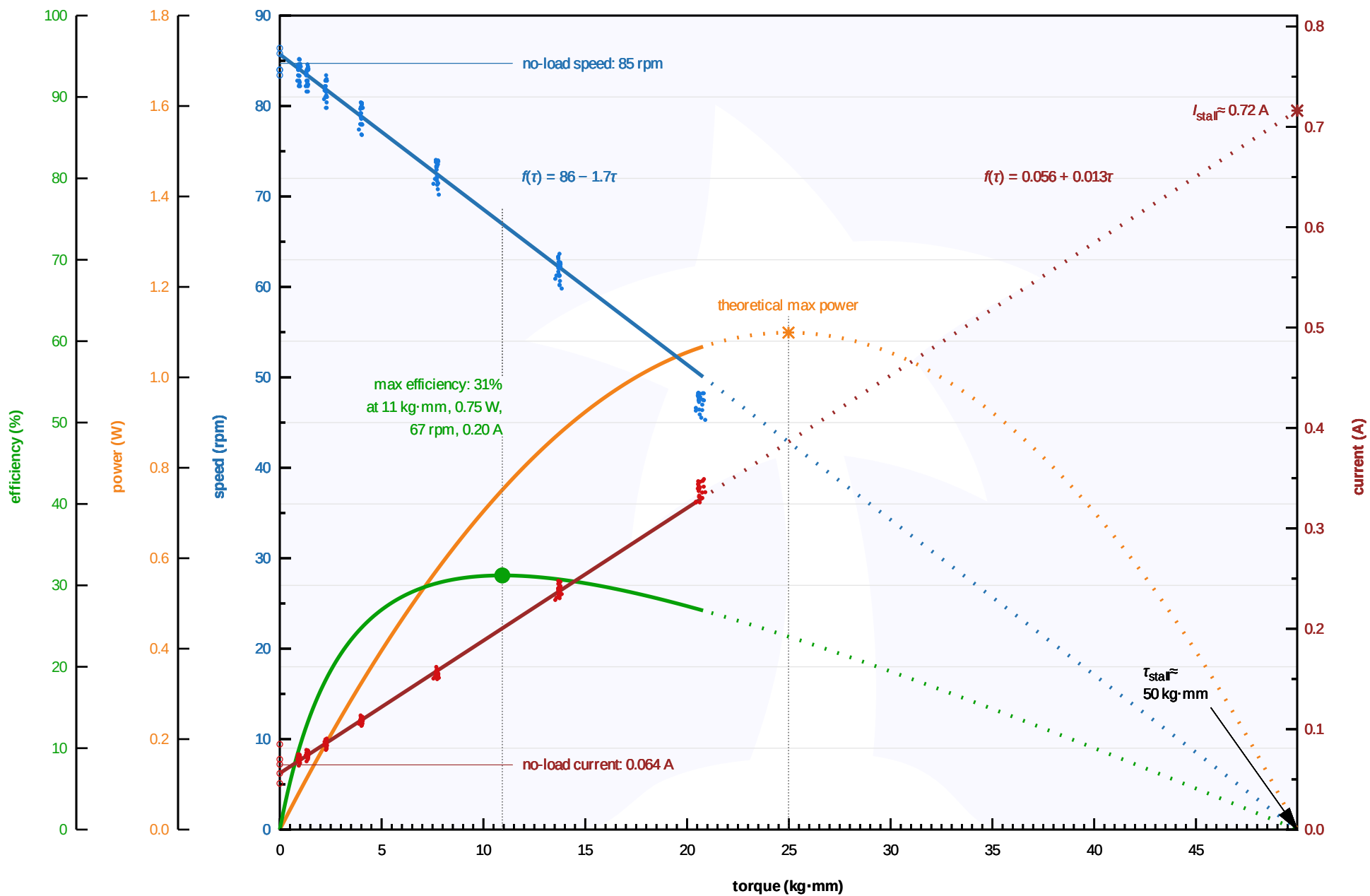

Pololu Items #3046, #3057 (1000:1 Micro Metal Gearmotor HPCB 12V) Performance at 12 V

